

Republic



of Zambia

ZAMBIA INDUSTRIAL PROPERTY JOURNAL

*The official Journal of Patents, Trade Marks and Designs
for the Zambia Patent Office*

PUBLISHED MONTHLY



Patents and Companies Registration Agency

VOL. 1, No. 3

25th March, 2024

THE JOURNAL AND WIPO STANDARDS

Publication of the Journal as to Statutory Requirements

THE ZAMBIA INDUSTRIAL PROPERTY JOURNAL is the official journal of industrial property for the Zambia Patent Office. The authority for its periodic publication is derived from Section 14 of the Patents Act; Section 14 of the Industrial Designs Act; and Section 80 of the Trade Marks Act.

Publication of the Journal as to WIPO Standards

The Journal is published, as far as feasible, in conformity to World Intellectual Property Organisation (WIPO) Standards ST 3, 5, 9 - 11, 17 - 20, 60 and 80 and other supporting Standards issued by WIPO for publication of or for presentation of Industrial property (IP) bibliographic data in official IP gazettes. Upgrading of the Journal to the Standards is a standing routine. All codes used in the Journal are explained in the section Key to Codes Used in the Journal.

CLOSING TIME FOR ACCEPTANCE OF COPY

Where to send "Copy" intended for Publication

All proofs intended for publication in the Journal (accompanying appropriate payment properly addressed, see modes of paying for advertisement below under 'Conditions for Advertising') must be forwarded to the Registrar & CEO at either address shown in 'Miscellany' below.

Closing Time for Receipt of "Copy"

Closing time for the receipt by the Registrar & CEO of any 'copy' is 15:30 hours on the last working day of the month immediately preceding the publication date of the issue in which publication is intended. Any 'copy' received thereafter will be held over for publication in the following issue.

ADVERTISEMENT AND SUBSCRIPTION RATES

Advertisement Rates

Advertisements for publication of acceptance proof for a single insertion is K500.00. Advertisements for publication in two or more consecutive issues is K500.00 for the first insertion and K400.00 for every subsequent insertion made in consecutive issues.

All errata advertisements are subject to these charges which are payable, however, only if the mistake necessitating the re-advertisement is the advertiser's shall the re-advertisement be without charge.

Subscription Rates

The Journal costs K100.00 per copy and the basic annual subscription (i.e. January to December) is K1, 200.00 if the copies are collected from the Intellectual Property Office (IPO) without a need for posting. For annual subscriptions to addresses outside Zambia, add to the basic cost another K20.00 annual postage for each copy ordered. For local addresses add K10.00 per copy. Subscriptions (see modes of payment below) must be sent in advance to the Registrar & CEO at the IPO.

CONDITIONS FOR ADVERTISING

Authorisation for Advertisement

No advertisement will be accepted for publication in the Journal unless it has been approved, and it actually carries proof of such authorisation, by the Registrar & CEO, as the case may be, for publication.

Responsibility for consequence of Advertisement

Neither the Government of the Republic of Zambia nor the Registrar & CEO, accepts any responsibility for cases arising from errors or omissions in any advertisement and neither does the Government nor the Registrar, guarantee the accuracy of any particular publication in the journal.

Modes of Paying for Subscription Advertisement

All payments for subscription, purchase of single copies and for advertising in the Journal must be made to the Registrar & CEO at the IPO and may be so made by cash, cheques, bank drafts, postal orders or money orders. These forms of payment, other than cash, must be crossed and made payable to the 'Zambia Patent and Trade Marks Journal Account.'

Proofs for Label/Device Marks to be Accompanied by an Exact Representation

Every proof submitted for publication of a label/device trade mark must be accompanied by a specimen representation of the label/device trade mark corresponding, in all material respects, to the representation submitted previously to the IPO on the relevant type of application. Any label/device trade mark proof not accompanied by this specimen or accompanied by a bad photocopy of this specimen will not be accepted for publication.

MISCELLANY

Address of Enquiry or of Correspondence

All-enquiry or correspondence concerning all matters on patents, trademarks, industrial designs and any other aspect of industrial property in Zambia, or matters about purchase of or subscription to the Journal or about anything published or intended to be published in the Journal should be presented either in person, to the IP Dept, 1st Floor North Wing, PACRA House, Plot No. 8471, Haile Selassie Avenue, Longacres, Lusaka or by post to the Registrar & CEO, Zambia Intellectual Property Office, P.O. Box 32020, Lusaka, (10101), Zambia.

General Advertisement of Employment, Meetings (etc.) in the Industrial Property Field

Readers of this Journal are being informed that advertisements are accepted for publication in the Journal concerning any general news or information in the intellectual property field such as employment offered or sought, meetings, etc. Submissions and enquiries should be made to the IPO at the above address.

THIS JOURNAL

The Zambia Industrial Property Journal is a national publication of the Intellectual Property Office (IPO). It is published, only in English, on the 25th of every month.

EVERY CORRESPONDENCE TO THE IPO TO BE ADDRESSED TO:

The Registrar & CEO

GENDER REPRESENTATION

Any masculine terms used in this publication include females. [Aiding interpretation of section 4(2) of the Interpretation and General Provisions Act (Cap. 2).]

FRONT COVER

Depicts the Label of the Patents & Companies Registration Agency (PACRA) an executive agency of the Ministry of Commerce, Trade and Industry (MCTI). The Intellectual Property Office is a unit of the PACRA.

BACK COVER

The maxim appearing on the verso of the back cover is used in this publication to underline the importance of any official intellectual property gazette, such as this journal, as a tool for location of the source, and dissemination, of, as in this case, industrial property information.

THE JOURNAL AND WIPO STANDARDS	2
PATENT APPLICATIONS COMPLETE SPECIFICATIONS ACCEPTED. (BB/CA) COMPLETE	6
ACCEPTED APPLICATIONS FOR REGISTRATION OF TRADE MARKS - CONDITIONAL. (BB/CA)	59
TRADE MARK APPLICATIONS ADVERTISED BEFORE ACCEPTANCE. (CA)	73
ACCEPTED TRADE MARK APPLICATIONS FILED FOR REGISTRATION UNDER THE MADRID PROTOCOL FOR THE REGISTRATION OF INTERNATIONAL MARKS.(CA)	75
TRADE MARKS REGISTERED. (FG).	90
ALTERATION OF REGISTERED TRADE MARKS (TH/CA)	127
TRADE MARK REGISTRATIONS RENEWED FOR FEBRUARY, 2024. (ND)	129
STATUTORY NOTICES UNDER THE TRADE MARKS ACT (CAP. 401)	164
STATUTORY NOTICES UNDER THE TRADE MARKS ACT (CAP. 401)	165
INDUSTRIAL DESIGNS FILED DURING FEBRUARY, 2024. (AA)	166
INID CODES FOR DETAILS OF ANNOUNCEMENTS	175
LETTER CODES (STATUS CODES) FOR HEADINGS OF ANNOUNCEMENTS (WIPO ST.17)	177

STATUTORY NOTICES UNDER THE PATENTS ACT (NO. 40)
PATENT APPLICATIONS COMPLETE SPECIFICATIONS ACCEPTED. (BB/CA)

specifications of the undermentioned applications for letters have been accepted by the Registrar of Patents and can now be inspected by the public at the Patents Office, at a charge, during business hours. Photocopies of these specifications, drawings and other documents of these applications are obtainable, at a charge, from the Patent Office. In terms of section 56 of the Patents Act, any person interested may within three months of the date of publication hereof (or within such further period as the Registrar may, on application to him within that period allow or, with the consent of the patent applicant, at any time before the grant of a patent on the application) object to the grant of the patent by filing at the Patent Office a notice of opposition on Patents Form No. 12.

(11) 14/2021

(22) 27.05.2021

(71) Katongo Musonda, House No. 29 Liberia Street, Nkana East, Kitwe.

(72) Katongo Musonda

(51) Int. Cl. F24C

(54) **Smart stove**

(57) The present invention relates to the field of cooking appliances, particularly to a smart stove designed to improve cooking efficiency, promote health and safety of users, and create a smart interactive cooking experience. More specifically, the invention pertains to a Zambian smart stove incorporating advanced technologies with smart features.

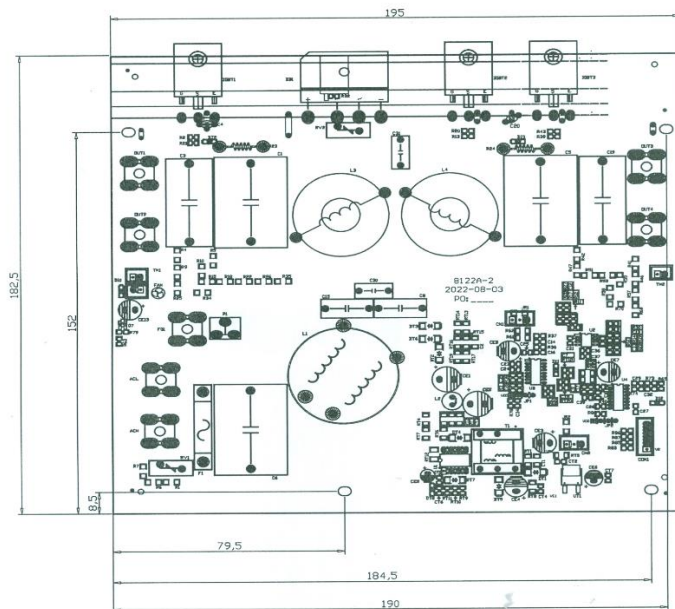

Fig-1

(21) 16/2022;

(22) 10.11.2022

(31) PCT/EP2021/057957

(32) 26.03.2021 (33) EP

(71) SMS Group GMBH, Eduard-Schloemann-Str, 4, Dusseldorf, 40237, Germany.

(72) Schuring Andreas and Borowski, Nikolaus Peter Kurt.

(51) Int Cl. F27D.

(54) Gas injection Device

(57) A gas injection device (1) for introducing a process gas into a non-iron molten metal and/or slag in particular a molten copper and/or copper slag, comprising a hollow-cylindrical lance (2) which is made of a refractory material and/or graphite, preferably a lance which consists of a refractory material and/or graphite, wherein the lance (2) has an inlet opening (5) for the process gas and a gas injection module (9,23,27) which is connected to the hollow-cylindrical lance (2) and is made of a refractory material and/or graphite, preferably a gas injection module which consists of a refractory material and/or graphite, comprising at least one outlet opening (12) for the process gas, and the outlet opening (12) comprises at least one element (13) which is made of a ceramic material and through which a gas can flow and the process gas is introduced into the molten metal.

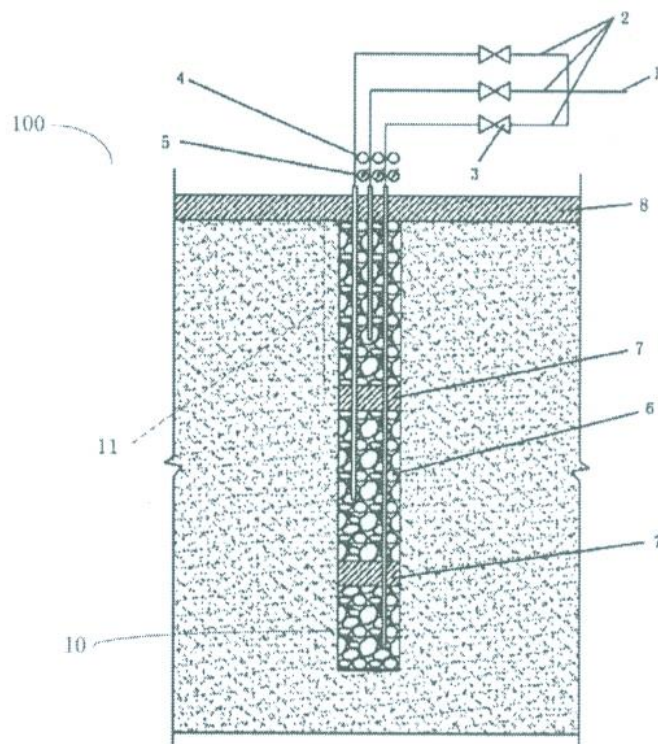

STATUTORY NOTICES UNDER THE TRADE MARKS ACT (CAP. 401)

ACCEPTED APPLICATIONS FOR REGISTRATION OF TRADE MARKS - ABSOLUTE. (BB/CA)

NOTICE IS HEREBY GIVEN, that any person who has ground of opposition to registration of the following trade marks may, within two months of the date of publication hereof, file a notice of opposition on Form T.M. No. 6 with the Registrar of Trade Marks, Zambia Patent Office.

Preferably, any objector must file the notice of opposition only after writing the applicant to give him reasonable notice about the intended opposition in order to afford him an opportunity of withdrawing his application. Failure to do this will be taken into account in considering any application by any party for an order for costs if the opposition is uncontested by the applicant. A letter B, C, or D prefixed to the application number means that the application is for registration, respectively, in Part B, C (certification mark) or D (defensive mark) of the register of trade marks. If an application proceeds in Part A, the application number is unaccompanied by any letter.

(210) 56/2016; (220) 20.01.2016

(731) Truworhts Limited of No. 1 Mostert Street, Cape Town, South Africa.

(740) Fisher, Cormack & Botha, P.O Box 33890, Lusaka, Zambia.

(511) Int.Cl.25

(510) Clothing, footwear, headgear.

(540) **INWEAR**

(210) 205/2019; (220) 09.02.2019

(731) Truworhts Limited of No. 1 Mostert Street, Cape Town, South Africa.

(740) Fisher, Cormack & Botha, P.O Box 33890, Lusaka, Zambia.

(511) Int.Cl.25

(510) clothing, footwear, headgear.

(540) **INWEAR**

(210) 890/2022; (220) 13.06.2022

(731) Safari Manufacturing CC of 16 Pioneer Street, Pacaltsdrop, Industria, George 6530, South Africa.

(740) Fisher, Cormack & Botha, P.O. Box 33890, Lusaka, Zambia.

(511) Int.Cl.4

(510) Industrial oils and greases, wax; lubricants; dust absorbing, wetting and binding compositions; fuels (including motor spirit) and illuminants; candles and wicks for lighting.

(540)



(210) 55/2023; (220) 13.01.2023

(731) UPL Mauritius Limited of 6th Floor, Suite 157B, Harbor Front Building, President John Kennedy Street, Port Louis, Mauritius.

(740) Christopher, Russell Cook & Co., The Office @4658/A Chikwa Road, Opposite Old Magistrate Court, P.O Box 34091, Lusaka, Zambia.

(511) Int.Cl.5

(510) Herbicides, pesticides, insecticides, fungicides, vermicides, rodenticides, weedicides, preparations for killing weeds and destroying vermin.

(540) **LIMPOPO**

(210) 652/2023; (220) 13.11.2023.

(731) Deep Dive LLC, Corporation Trust Center, 1209 Orange Street Wilmington, Delaware 19801, United States of America.

(740) Ellis & Co, 8 Tito Road Rhodes Park Phillip Ellis House, Lusaka, Zambia.

(511) Int Cl.9.

(510) Digital recordings; downloadable electronic publications; educational software; electronic instructional and teaching apparatus and instruments; computer programs and web-based audio-visual content for broadcast or other transmission on television,

radio, mobile telephones, personal digital assistants, personal computers and computer peripherals; thermal imaging cameras; apparatus for recording, broadcasting, transmission, receiving, processing, generating, reproducing, distributing, re-distributing, tracking, tagging, encoding and decoding of audio and video content, still and moving images, data and metadata; magnetic data carriers, recording discs, memory carriers, compact discs, interactive compact discs, CD-ROMs and DVDs, mini-disks, tapes, cassettes and cartridges; computer software; computer game software; video game programs; computer software for-use as an application programming interface for building software applications; downloadable audio files, image files, video files, music files and multimedia content; computers; handheld computers; wearable computers; computer hardware; computer peripherals; wearable peripherals for playing video games; controllers for use with interactive digital multimedia content; digital music, audio and video recordings (downloadable) from the Internet; electronic bulletin boards; application development software; computer software for setting up, configuring, operating, and controlling computers, computer peripherals, and audio and video players; operating system software; cleaning apparatus for phonograph records; crash test dummies; downloadable image files; downloadable music files; downloadable ring tones for mobile phones; eyeglass cases; eyeglass chains; eyeglass cords; eyeglass frames; 3D spectacles; eyewear; eyeglasses; sunglasses; optical glass; optical goods; optical apparatus and instruments; optical lenses; eyeglass lenses; contact lenses; containers for contact lenses; correcting lenses; 'spectacle frames; fire hose nozzles; interfaces for computers; computer monitors; display screens; head-mounted displays; interactive touchscreens; life belts; life buoys; life net , life-saving rafts; magnets; magnets (decorative); masts for wireless aerials; mouse pads; reflecting discs for wear, for the prevention of traffic accidents; respiratory for filtering air; safety restaurants other than for vehicle seats and sports equipment; sprinkler systems for fire protection; stands for Photographic apparatus; tripods for cameras; wrist rests for use with computers; parts and fittings for the aforesaid in class 09.

(541) **"XROS"**

(210) 1000/2023; (220) 05.07.2023

(731) Dell Inc. of One Dell Way Round Rock, Texas 78682, United States of America.

(740) Galloway & Co., Plot No. 11 Chabisa Road, Woodlands, Lusaka, Zambia.

(511) Int.Cl.9

(510) Hardware (Computer-); computers; software; computer. servers; desktop computers; notebook computers; laptop computers; computer components and parts; computer monitors; computer memory hardware; computer operating software; computer networking hardware; network access server hardware; NAS (Network attached storage); operating software; tablet PCs; personal computers; handheld computers; TV monitors; printers; scanners; fax machines; computer docking station; batteries; battery chargers; power adapters; headphones; projectors; speakers; wireless controllers to remotely monitor and control the function and status of other electrical, electronic, and mechanical devices or systems; hard disk drives; CD rom drives; digital video disc drives; optical disk drives; computer peripherals; keyboards; computer mouse; communications processors; pulse code modulating processors; modems; tape drives; PC cards; memory cards; smart cards; Ethernet cards; memory devices; Add-on-cards for computers; memory boards; electronic memory integrated circuit chips; electrical cable; audio cable; communications cables; power cables; electric cables; cable connectors; cable adapters; coaxial cable connectors; electricity connectors; coaxial connectors; power connectors; electrical connectors; electronic connectors; adapter connectors (electric-); wire connectors (electricity); computer operating software; utility software; Computer software packages; data storage devices; data storage apparatus; Apparatus for data processing; computer software to enable retrieval of data; data processors; communications processors; video processors; sound processors; voice processors; processors (central processing units); data networks; computer networks; data transmission networks; computer memories; electronic memories; disc memories; external memories for cell-phones; memories for use with computers; operating software; optical data storage drives; Apparatus for data storage; data,processing software; computer software for processing market information; computer software to enable the provision of information via the Internet; computer software to enable the provision of information via communications networks; data protection backup units; computer software; network management software; telecommunications software; network access server operating software; computer software for document management; memory storage devices; Storage apparatus for computer data; storage apparatus for computer programs; personal computer application

software for managing document control systems; computer software for the collection of positioning data; computer software for analysing market information; software for searching and retrieving information across a computer network; computer software for creating searchable databases of information and data; computer hardware; application software for cloud computing services; computer interface software; computer software for controlling and managing access server applications; computer programs for project management; computer software applications; computer software applications, downloadable; computer networks; network management software; computer components and parts; information technology and audiovisual equipment; data storage media.

(540) **DELL**

(210) 1016/2023; (220) 03.07.2023.

(731) Caterpillar Energy Solutions Gmbh, Carl-Benz-Str. 1, D-68167 Mannheim, Germany.

(740) Christopher, Russell Cook & Co., The Office @ 4658/A Chikwa Road, P.O Box 34091, Lusaka, Zambia.

(511) Int Cl.16.

(510) Paper and cardboard; printed matter; bookbinding material; photographs; stationery and office requisites, except furniture; adhesives for stationery or household purposes; drawing materials and materials for artists; paintbrushes; instructional and teaching materials; plastic sheets, films and bags for wrapping and packaging; printers' type, printing blocks; Printed matter and publications relating to the construction, installation, repair, design, controlling and monitoring of the operation of equipment that consumes or generates power.

(540)



(210) 1247/2023; (220) 02.08.2023

(731) Umoja Shoe Company Ltd of P.O. Box 452, Mtwapa, 80109, Mombasa-Malindi Highway, Kikambala, Kenya.

(740) Christopher, Russell Cook & Co., The Office @ 4658/A Chikwa Road, Opposite Old Magistrate Court, P.O Box 34091, Lusaka, Zambia.

(511) Int.Cl.25

(510) Footwear, Clothing, Headgear.

(540)



(210) 1265/2023; (220) 03.08.2023

(731) Precision Packaging Limited of Stand No. 12621, off Mumbwa Road, Chinika, P.O Box 31446, Lusaka, Zambia.

(740) Christopher, Russell Cook and Co., The Office @ 4658/A, Chikwa Road, Opposite Old Magistrate Court, P.O Box 34091, Lusaka, Zambia.

(511) Int.Cl.20

(510) Bins, not of metal/chests, not of metal, bottle racks, bottle caps, not of metal, bottle closures, not of metal, bottle closures, not of metal/stoppers for bottles, not of glass, metal or rubber, boxes of wood or plastic, brackets, not of metal, for furniture, clips, not of metal, for cables and pipes, clips of plastic for sealing bags, closures, not of metal, for containers, containers, not of metal, for liquid fuel, containers, not of metal [storage, transport], decorations of plastic for foodstuffs, edgings of plastic for furniture, floating containers, not of metal, jerrycans, not of metal, labels of plastic, packaging containers of plastic, plugs, not of metal / bungs, not of metal, reservoirs, not of metal nor of masonry / tanks, not of metal nor of masonry, screw tops, not of metal, for bottles, stoppers, not of metal/sealing caps, not of metal, tables, transport pallets, not of metal.

(540)



-
- (210) 1266/2023; (220) 03.08.2023
- (731) Precision Packaging Limited of Stand No. 12621, off Mumbwa Road, Chinika, P.O Box 31446, Lusaka, Zambia.
- (740) Christopher, Russell Cook and Co., The Office @ 4658/A, Chikwa Road, Opposite Old Magistrate Court, P.O Box 34091, Lusaka, Zambia.
- (511) Int.Cl.20
- (510) Bins, not of metal/chests, not of metal, bottle racks, bottle caps, not of metal, bottle closures, not of metal, bottle closures, not of metal/stoppers for bottles, not of glass, metal or rubber, boxes of wood or plastic, brackets, not of metal, for furniture, clips, not of metal, for cables and pipes, clips of plastic for sealing bags, closures, not of metal, for containers, containers, not of metal, for liquid fuel, containers, not of metal [storage, transport], decorations of plastic for foodstuffs, edgings of plastic for furniture, floating containers, not of metal, jerrycans, not of metal, labels of plastic, packaging containers of plastic, plugs, not of metal / bungs, not of metal, reservoirs, not of metal nor of masonry / tanks, not of metal nor of masonry, screw tops, not of metal, for bottles, stoppers, not of metal/sealing caps, not of metal, tables, transport pallets, not of metal.

(540)



-
- (210) 1268/2023; (220) 03.08.2023
- (731)(750)Sabipay Technologies Limited of P. O. Box 35868, Lusaka, Zambia.
- (511) Int.Cl.9
- (510) Scientific, nautical, surveying, photographic, cinematographic, optical, weighing, measuring, signalling, checking (supervision), life-saving and teaching apparatus and instruments; apparatus and instruments for conducting, switching, transforming, accumulating, regulating or controlling electricity; apparatus for recording, transmission or reproduction of sound or images; magnetic data carriers, recording discs; compact discs, DVDs and other digital recording media; mechanisms for coin-operated apparatus; cash registers, calculating machines, data processing equipment, computers; computer software; fire-extinguishing apparatus.

(540)



(210) 1282/2023; (220) 08.08.2023

(731) Canaan Creative Global Pte. Ltd of 28 Ayer Rajah Crescent # 06-08, 139959, Singapore.

(740) Christopher Russell Cook & Co., The Office @ 4658/A Chikwa Road, Opposite Old Magistrates Court, P.O. Box 34091, Lusaka, Zambia.

(511) Int.Cl.9

(510) Computer software, recorded; Computers; Computer peripheral devices; Data processing apparatus; Central processing units [processors]; Couplers [data processing equipment]; Integrated circuit cards [smart cards]; Interfaces for computers; Integrated circuits; Chips [integrated circuits]; Downloadable digital files authenticated by non-fungible tokens [NFTs]; Downloadable computer software for managing crypto asset transactions using blockchain technology; Downloadable cryptographic keys for receiving and spending cryptocurrency.

(540)



(210) 1360/2023; (220) 21.08.2023

(731) Akila Trading (Proprietary) Limited of 857 Voortrekker Road, Maitland, 7405, Western Cape, South Africa.

(740) Christopher Russell Cook & Co., The Office @ 4658/A Chikwa Road, Opposite Old Magistrates Court, P.O. Box 34091, Lusaka, Zambia.

(511) Int.Cl.5

(510) Dietetic food and substances adapted for medical or veterinary use, food for babies; dietary supplements for human beings and animals.

(540) **AKILA**

(210) 1361/2023; (220) 21.08.2023

(731) Akila Trading (Proprietary) Limited of 857 Voortrekker Road, Maitland, 7405, Western Cape, South Africa.

(740) Christopher Russell Cook & Co., The Office @ 4658/A Chikwa Road, Opposite Old Magistrates Court, P.O. Box 34091, Lusaka, Zambia.

(511) Int.Cl.29

(510) Meat, fish, poultry and game; meat extracts; preserved, frozen, dried and cooked fruits and vegetables; jellies, jams, compotes; eggs; milk, cheese, butter, yogurt and milk products; oils and fats for food ; beans, pulses; nuts; lentils; processed peas.

(540) **AKILA**

(210) 1649/2023; (220) 22.09.2023

(731)(750)Digital Shared Services Limited of 6 Nyati Close, Rhodes Park, Lusaka, Zambia.

(511) Int.Cl.9

(510) Scientific, nautical, surveying, photographic, cinematographic, optical, weighing, measuring, signalling, checking (supervision), life-saving and teaching apparatus and instruments; apparatus and instruments for conducting, switching, transforming, accumulating, regulating or controlling electricity; apparatus for recording, transmission or reproduction of sound or images; magnetic data carriers, recording discs; automatic vending machines and mechanisms for coin-operated apparatus; cash registers, calculating machines, data processing equipment and computers; fire-extinguishing apparatus.

(540)



-
- (210) 1687/2023; (220) 04.10.2023
- (731) Nihon Nohyaku Co. Ltd of 19-8, Kyobashi 1-Chome, Cuo-ku, Tokyo, Japan.
- (740) Christopher, Russell Cook & Co., The Office @ 4658/A Chikwa Road, Opposite Old Magistrate Court, P.O. Box 34091, Lusaka, Zambia.
- (511) Int.Cl.5
- (510) Pesticides; insecticides; fungicides; herbicides; miticides; acaricides.
- (540) **TAKUMI**

-
- (210) 1690/2023; (220) 05.10.2023
- (731) Cipla Limited of Cipla House, Peninsula Business Park, Ganpatrao Kadam Marg, Lower Parel, Mumbai-400013, Maharashtra, India.
- (740) Christopher, Russell Cook & Co., The Office @ 4658/A Chikwa Road, Opposite Old Magistrate Court, P.O Box 34091, Lusaka, Zambia.
- (511) Int.Cl.5
- (510) Pharmaceuticals, medical and veterinary preparations; sanitary preparations for medical purposes; dietetic food and substances adapted for medical or veterinary use, food for babies; dietary supplements for human beings and animals; plasters, materials for dressings; material for stopping teeth, dental wax; disinfectants; preparations for destroying vermin; fungicides, herbicides.
- (540) **NINTIB**

-
- (210) 1691/2023; (220) 05.10.2023
- (731) Upjohn Manufacturing Ireland Unlimited Company of Little Island, County Cork, T45 F65, Ireland.
- (740) Fisher, Cormack & Botha, P.O Box 33890, Lusaka, Zambia.

(511) Int.Cl.5

(510) Pharmaceutical preparations for use in the treatment of high cholesterol.

(540) **LIPITOR E**

(210) 1783/2023; (220) 17.10.2023

(731) The Standard Bank of South Africa Limited of 5 Simmonds Street, Johannesburg, 2001, Gauteng, South Africa.

(740) Christopher Russell Cook & Co., The Office @ 4658/A Chikwa Road, Opposite Old Magistrates Court P.O. Box 34091, Lusaka, Zambia.

(511) Int.Cl.16

(510) Paper, cardboard and goods made from these materials, not included in other classes; printed matter; books, magazines, manuals, newspapers, newsletters, pamphlets; bookbinding material; photographs; stationery; adhesives for stationery or household purposes; artists' materials; paint brushes; typewriters, office requisites (except furniture); instructional and teaching materials (except apparatus); wrapping and packaging materials; plastic materials for packaging (not included in other classes); printers' type; printing blocks; printed publications; newsletters, reviews and publications; documentation relating to financial, banking, insurance and investment services or transactions; advertising materials; brochures, vouchers, cheques, cheque books; cheque book holders; paying-in books; bank cards, cash cards, cheque cards, debit cards, credit cards, charge cards, loyalty or gift cards all being other than encoded or magnetic cards.

(540) **BUSINESS ONLINE**

(210) 1786/2023; (220) 17.10.2023

(731) The Standard Bank of South Africa Limited of 5 Simmonds Street, Johannesburg, 2001, Gauteng, South Africa.

(740) Christopher Russell Cook & Co., The Office @ 4658/A Chikwa Road, Opposite Old Magistrates Court P.O. Box 34091, Lusaka, Zambia.

(511) Int.Cl.9

(510) Scientific, nautical, surveying, photographic, cinematographic, optical, weighing, measuring, signaling, checking (supervision), life-saving and teaching apparatus and instruments; electric and electronic apparatus and hardware, equipment for the storage and transmission of data and information for use in relation to banking, financial, insurance and general commercial transactions, including those conducted online via the Internet or a computer network, or by telephone or cellular telephone; software, systems, devices and platforms used to enable and facilitate electronic banking, financial, insurance or other commercial transactions, including those via the Internet or a computer network, or by telephone or cellular telephone; including data processing equipment and software for use in relation to banking and financial services including data processing equipment and software; downloadable electronic publications; apparatus and equipment for the electronic transfer of and/or financial data; telecommunication equipment; automated teller machines; money dispensing machines, electronic fund transfer, payment or point of sale apparatus, machines and terminals; card and bar code scanners; magnetic and magnetically encoded cards; programmable cards; smart cards; cards bearing coded data in magnetic form; cards bearing data for use in computers; cards bearing coded data in punched-out form; cards bearing data for use in data processing apparatus; cards bearing data for use in data storage apparatus; cards bearing electronically recorded data; cards bearing integrated circuits; cards bearing magnetic or encoded data for input; cards bearing micro-chips and computer cards containing chips; credit, charge, debit and/or cash cards; prepayment cards [encoded]; loyalty or gift cards [encoded], readers, scanners, parts and fittings for the aforementioned goods.

(540) **SMART MAHAFU**

(210) 1806/2023;

(220) 19.10.2023

(731) Woodlands Dairy (Proprietary) Limited of Woodlands, P.O. Box 4, Humansdorp 6300, South Africa.

(740) Christopher, Russell Cook & Co., The Office @ 4658/A Chikwa Road, Opposite Old Magistrate Court, P.O Box 34091, Lusaka, Zambia.

(511) Int.Cl.29

(510) Meat, fish, poultry and game; meat extracts; preserved, frozen, dried and cooked fruits and vegetables; jellies, jams, compotes, fruit sauces; eggs; milk and milk products, flavoured milk, milk based energy drinks; edible oils and fats.

(540)



(210) 1807/2023; (220) 19.10.2023

(731) Woodlands Dairy (Proprietary) Limited of Woodlands, P.O. Box 4, Humansdorp 6300, South Africa.

(740) Christopher, Russell Cook & Co., The Office @ 4658/A Chikwa Road, Opposite Old Magistrate Court, P.O Box 34091, Lusaka, Zambia.

(511) Int.Cl.30

(510) Coffee, tea, cocoa and artificial coffee; rice; tapioca and sago; flour and preparations made from cereals; bread, pastry and confectionery including puddings, desserts and powders and substances for making such puddings and desserts included in the class; ices; sugar, honey, treacle; products containing milk; yeast, baking-powder; salt; mustard; vinegar, sauces (condiments); spices; ice.

(540)



- (210) 1808/2023; (220) 19.10.2023
- (731) Woodlands Dairy (Proprietary) Limited of Woodlands, P.O. Box 4, Humansdorp 6300, South Africa.
- (740) Christopher, Russell Cook & Co., The Office @ 4658/A Chikwa Road, Opposite Old Magistrate Court, P.O Box 34091, Lusaka, Zambia.
- (511) Int.Cl.32
- (510) Beers, mineral and aerated waters; non-alcoholic drinks; fruit beverages and fruit juices, milk based beverages, including flavoured milk based beverages, energy drinks; syrups and other preparations for making beverages.
- (540)



-
- (210) 1812/2023; (220) 23.10.2023
- (731) Clicks Retailers Proprietary limited of Cnr Searle & Pontac Streets, Cape Town, Western Cape, South Africa.
- (740) Christopher Russell Cook & Co., The Office @ 4658/A Chikwa Road, Opposite Old Magistrates Court P.O. Box 34091, Lusaka, Zambia.
- (511) Int.Cl.27
- (510) carpets, rugs, mats and matting; linoleums and other materials for covering floors; wall hangings (non-textile).
- (540) **SAFEWAY**

-
- (210) 1930/2023; (220) 26.10.2023
- (731) Phillip Morris Products S.A. of Quai Jeanrenaud 3, Neuchatel 2000, Switzerland.
- (740) Christopher, Russell Cook & Co., The Office @ Plot No 4658/A Chikwa Road, Opposite Old Magistrate Court, P.O Box 34091, Lusaka, Zambia.

(511) Int.Cl.34

(510) Wired vaporizer for electronic cigarettes and electronic smoking devices; tobacco, raw or manufactured; tobacco products, including cigars, cigarettes, cigarillos, tobacco for roll your own cigarettes, pipe tobacco, chewing tobacco, snuff tobacco, kretek; snus; tobacco substitutes (not for medical purposes); smokers articles, including cigarette paper and tubes, cigarette filters, tobacco tins, cigarette cases and ashtrays for smokers, pipes, pocket apparatus for rolling cigarettes, lighters for smokers; matches; tobacco sticks, tobacco products for the purpose of being heated, electronic devices and their parts for the purpose of heating cigarettes or tobacco in order to release nicotine-containing aerosol for inhalation; liquid nicotine solutions for use in electronic cigarettes; electronic smoking devices; electronic cigarettes; electronic cigarettes as substitute for traditional cigarettes; electronic devices for the inhalation of nicotine containing aerosol; oral vaporising devices for smokers, tobacco products and tobacco substitutes; smoker's articles for electronic cigarettes; parts and fittings for the aforesaid products included in class 34; devices for extinguishing heated cigarettes and cigars as well as heated tobacco sticks; electronic rechargeable cigarette cases.

(540)



(210) 1943/2023;

(220) 30.10.2023

(731) Clicks Retailers Proprietary Limited of Cnr Searle & Pontac Street, Cape Town, Western Cape, South Africa.

(740) Christopher, Russell Cook & Co., The Office @ 4658/A Chikwa Road, Opposite Old Magistrate Court, P.O Box 34091, Lusaka, Zambia.

(511) Int.Cl.29

(510) Meat, fish, poultry and game; meat extracts; preserved, frozen, dried and cooked fruits and vegetables; dried nuts; dried fruit mixes; jellies, jams, compotes; eggs; milk and milk products; edible oils and fats; olive oil.

(540)



(210) 1944/2023; (220) 30.10.2023

(731) Clicks Retailers Proprietary Limited of Cnr Searle & Pontac Street, Cape Town, Western Cape, South Africa.

(740) Christopher, Russell Cook & Co., The Office @ 4658/A Chikwa Road, Opposite Old Magistrate Court, P.O Box 34091, Lusaka, Zambia.

(511) Int.Cl.30

(510) Coffee, tea, cocoa and artificial coffee; hot chocolate; chocolate powder; rice; tapioca and sago; flour and preparations made from cereals; bakery goods; rusks; bread, pastry and confectionery; mixes for the preparation of bread; biscuits; chocolates; marshmallows; chocolate sauces; chocolate chips; preparations for making bakery products; ices; sugar, honey, treacle; yeast, baking-powder; salt; mustard; vinegar, sauces (condiments); spices; ice; chilli oil; popcorn.

(540)



(210) 1945/2023; (220) 30.10.2023

(731) Clicks Retailers Proprietary Limited, of Cnr Searle & Pontac Streets, Cape Town, Western Cape, South Africa.

(740) Christopher, Russell Cook & Co., The Office @ 4658/A Chikwa Road, Opposite Old Magistrate Court, P.O Box 34091, Lusaka, Zambia.

(511) Int.Cl.30

(510) Coffee, tea, cocoa and artificial coffee; rice, pasta and noodles; tapioca and sago; flour and preparations made from cereals; bread, pastries and confectionery; mixes for the preparation of bread; biscuits; sweets; chocolates; wafers; marshmallows; chocolate sauces; chocolate chips; preparations for making bakery products; ice cream, sorbets and other edible ices; sugar, honey, treacle; yeast, baking-powder; salt, seasonings, spices, preserved herbs; vinegar, sauces and other condiments; ice (frozen water); snack foods made from cereal, grain, rice or maize.

(540)



(210) 1956/2023; (220) 30.10.2023

(731) Clicks Retailers Proprietary Limited of Cnr Searle & Pontac Street, Cape Town, Western Cape, South Africa.

(740) Christopher, Russell Cook & Co., The Office @ 4658/A Chikwa Road, Opposite Old Magistrate Court, P.O Box 34091, Lusaka, Zambia.

(511) Int.Cl.3

(510) Bleaching preparations and other substances for laundry use; cleaning, polishing, scouring and abrasive preparations; soaps; perfumery, essential oils, cosmetics, hair lotions; dentifrices.

(540) **ATOMIC**

(210) 1957/2023; (220) 30.10.2023

(731) Clicks Retailers Proprietary Limited of Cnr Searle & Pontac Street, Cape Town, Western Cape, South Africa.

(740) Christopher, Russell Cook & Co., The Office @ 4658/A Chikwa Road, Opposite Old Magistrate Court, P.O Box 34091, Lusaka, Zambia.

(511) Int.Cl.3

(510) Soaps; perfumery and fragrances; essential oils, cosmetics, hair lotions.

(540) **AIR & EARTH**

(210) 1976/2023; (220) 31.10.2023

(731) Stellenbosch Farmers' Winery Limited of Oude Libertas, Stellenbosch, South Africa.

(740) Galloway & Co., Plot No. 11 Chabisa Road, Woodlands, Lusaka, Zambia.

(511) Int.Cl.33

(510) Alcoholic beverages, except beers; alcoholic preparations for making beverages.

(540)



(210) 2019/2023; (220) 07.11.2023

(731)(750)Nyama Soya Limited of Plot No. 29381 off Mumbwa Road, Nampundwe Road, Light Industrial Area, P.O. Box 30824, Lusaka, Zambia

(511) Int.Cl.30

(510) Confectionary, candies, coffee, tea, cocoa and artificial coffee; rice, pasta and noodles; cereal bars, maize flakes, corn flakes, tapioca and sago; flour and preparations made from cereals; bread, pastries; chocolate; ice cream, sugar, honey, treacle; yeast, baking powder; salt, seasonings, spices, vinegar, sauces.

(540) **MUMMYS**

(210) 2095/2023; (220) 16.11.2023

25

- (731) Bridgestone Corporation of 1-1, Kyobashi 3-Chome, Chuo-ku, Tokyo, Japan.
- (740) Christopher, Russell Cook & Co., The Office @ 4658/A Chikwa Road, Opposite Old Magistrate Court, P.O Box 34091, Lusaka, Zambia.
- (511) Int.Cl.9
- (510) Computer programs and software for managing information of tires and vehicles.
- (540) **BRIDGESTONE TOOLBOX**
-

- (210) 2096/2023; (220) 16.11.2023
- (731) Bridgestone Corporation of 1-1, Kyobashi 3-Chome, Chuo-ku, Tokyo, Japan.
- (740) Christopher, Russell Cook & Co., The Office @ 4658/A Chikwa Road, Opposite Old Magistrate Court, P.O Box 34091, Lusaka, Zambia.
- (511) Int.Cl.16
- (510) Paper, cardboard and goods made from these materials; printed matter; publications; books, magazines, journals, periodicals and newsletters; advertising, promotional, marketing and packaging materials; stationery; cards, including business cards; photographs, signage, posters, flyers, banners and pictures; quotations, invoices and purchase orders; instructional, informative, educational and teaching materials, including training and operational manuals; all of the foregoing relating to services rendered in the automobile and tyre industries, and services relating to tyre performance diagnosis and management, including tyre retreading, repair and maintenance services.
- (540) **BRIDGESTONE TOOLBOX**
-

- (210) 2097/2023; (220) 28.11.2023
- (731) Bridgestone Corporation of 1-1, Kyobashi 3-Chome, Chuo-ku, Tokyo, Japan.
- (740) Christopher, Russell Cook & Co., The Office @ 4658/A Chikwa Road, Opposite Old Magistrate Court, P.O Box 34091, Lusaka, Zambia.
- (511) Int.Cl.9
- (510) Computer programs and software for managing information of tires and vehicles.

(540)



(210) 2098/2023; (220) 28.11.2023

(731) Bridgestone Corporation of 1-1, Kyobashi 3-Chome, Chuo-ku, Tokyo, Japan.

(740) Christopher, Russell Cook & Co., The Office @ 4658/A Chikwa Road, Opposite Old Magistrate Court, P.O Box 34091, Lusaka, Zambia.

(511) Int.Cl.16

(510) Paper, cardboard and goods made from these materials; printed matter; publications; books, magazines, journals, periodicals and newsletters; advertising, promotional, marketing and packaging materials; stationery; cards, including business cards; photographs, signage, posters, flyers, banners and pictures; quotations, invoices and purchase orders; instructional, informative, educational and teaching materials, including training and operational manuals; all of the foregoing relating to services rendered in the automobile and tyre industries, and services relating to tyre performance diagnosis and management, including tyre retreading, repair and maintenance services.

(540)



(210) 2099/2023; (220) 28.11.2023

(731) Bridgestone Corporation of 1-1, Kyobashi 3-Chome, Chuo-ku, Tokyo, Japan.

(740) Christopher, Russell Cook & Co., The Office @ 4658/A Chikwa Road, Opposite Old Magistrate Court, P.O Box 34091, Lusaka, Zambia.

(511) Int.Cl.9

(510) Computer programs and software for managing information of tires and vehicles.

(540)



(210) 2100/2023; (220) 16.11.2023

(731) Bridgestone Corporation of 1-1, Kyobashi 3-Chome, Chuo-ku, Tokyo, Japan.

(740) Christopher, Russell Cook & Co., The Office @ 4658/A Chikwa Road, Opposite Old Magistrate Court, P.O Box 34091, Lusaka, Zambia.

(511) Int.Cl.16

(510) Paper, cardboard and goods made from these materials; printed matter; publications; books, magazines, journals, periodicals and newsletters; advertising, promotional, marketing and packaging materials; stationery; cards, including business cards; photographs, signage, posters, flyers, banners and pictures; quotations, invoices and purchase orders; instructional, informative, educational and teaching materials, including training and operational manuals; all of the foregoing relating to services rendered in the automobile and tyre industries, and services relating to tyre performance diagnosis and management, including tyre retreading, repair and maintenance services.

(540)



(210) 2101/2023; (220) 16.11.2023

(731) South Bakels (Pty) Limited of 235 Main Road, Martindale, Johannesburg, 2093, South Africa.

(740) Christopher, Russell Cook & Co., The Office @ 4658/A Chikwa Road, Opposite Old Magistrate Court, P.O Box 34091, Lusaka, Zambia.

(511) Int.Cl.1

(510) Chemicals for use in industry, science and photography, as well as in agriculture, horticulture and forestry; unprocessed artificial resins, unprocessed plastics; fire extinguishing and fire prevention compositions; tempering and soldering preparations; substances for tanning animal skins and hides; adhesives for use in industry; putties and other paste fillers; compost, manures, fertilizers; biological preparations for use in industry and science.

(540) **EMULEC SSL**

(210) 2102/2023; (220) 16.11.2023

(731) Jagotec AG of Enterprise Office Plot No. 23-S, Messeplatz 10, 4058 Basel., Switzerland.

(740) Christopher, Russell Cook & Co., The Office @ 4658/A Chikwa Road, Opposite Old Magistrate Court, P.O Box 34091, Lusaka, Zambia.

(511) Int.Cl.5

(510) Pharmaceutical preparations with cannabinoids as active ingredient; prescription-only pharmaceutical preparations with cannabinoids as active ingredient; pharmaceutical preparations for inhalers with cannabinoids as active ingredient; prescription-only pharmaceutical preparations for inhalers with cannabinoids as active ingredient.

(540) **LUO**

(210) 2103/2023; (220) 16.11.2023

(731) Jagotec AG of Enterprise Office Plot No. 23-S, Messeplatz 10, 4058 Basel., Switzerland

(740) Christopher, Russell Cook & Co., The Office @ 4658/A Chikwa Road, Opposite Old Magistrate Court, P.O Box 34091, Lusaka, Zambia

(511) Int.Cl.10

(510) Medical inhalers containing cannabinoids; prescription-only medical inhalers containing cannabinoids.

(540) **LUO**

(210) 2207/2023; (220) 20.11.2023

(310) 2023-439; (320) 06.06.2023; (330) LI

(731) Apple Inc. Of One Apple Park Way Cupertino, California 95014, United States of America.

(740) Christopher, Russell Cook & Co., The Office @ 4658/A Chikwa Road, Opposite Old Magistrates Court P.O. Box 34090, Lusaka, Zambia.

(511) Int.Cl.18

(510) Luggage; suitcases; trunks; all purpose carrying bags; backpacks; sports and athletic bags; beach bags; bookbags; duffel bags; garment bags; shopping bags; school bags; tote bags; carrying cases; attache cases; briefcases; handbags; wallets; purses; vanity, toiletry, cosmetic and lipstick cases sold empty; cosmetic bags sold empty; business card cases; calling card cases and holders; credit card cases; document cases; key cases; leather straps.

(540) **APPLE VISION**

(210) 2208/2023; (220) 29.11.2023

(310) 2023-439 (320) 06.06.2023 (330) LI.

(731) Apple Inc. Of One Apple Park Way Cupertino, California 95014, United States of America.

(740) Christopher, Russell Cook & Co., The Office @ 4658/A Chikwa Road, Opposite Old Magistrates Court P.O. Box 34091, Lusaka, Zambia.

(511) Int.Cl.28

(510) Toys; games; playthings; playing cards; electronic hand-held game units; computer games, video games, and computer and video game apparatus, other than coin operated or those adapted for use with television receivers; body-building apparatus; fitness and exercise machines and equipment.

(540) **APPLE VISION**

(210) 2209/2023; (220) 29.11.2023

(731) Alpachino Trading (Pty) Ltd, of 52 Kubu Avenue, Riverhorse Valley, Business Estate, Newlands Estate, 4037, KwaZulu-Natal, South Africa.

(740) Christopher, Russell Cook & Co., The Office @ 4658/A Chikwa Road, Opposite Old Magistrates Court P.O. Box 34091, Lusaka, Zambia.

(511) Int.Cl.29

(510) Meat, fish, poultry and game; chicken burgers; flame grilled chicken; salads, including chicken salads; chicken nuggets; meat extracts; pre-prepared uncooked, semi-cooked and cooked foods; preserved, frozen, dried and cooked fruits and vegetables; jellies, jams, compotes; eggs; milk and milk products; edible oils and fats.

(540)



(210) 2210/2023; (220) 29.11.2023

(731) Chongqing Changan Automobile Co., Ltd of 260 Jianxin East Road, Jiangbei District, Chongqing, Peoples Republic of China.

(740) Christopher, Russell Cook & Co., The Office @ 4658/A Chikwa Road, Opposite Old Magistrates Court P.O. Box 34091, Lusaka, Zambia.

(511) Int.Cl.12

(510) Electric vehicles; Lorries; Cars; Motor cars; Shock absorbers for automobiles; Driving motors for land vehicles; Motors, electric, for land vehicles; Clutches for land vehicles; Motor homes; Automobile bodies.

(540) **NEVO**

(210) 2211/2023; (220) 29.11.2023

(731) Multichoice Africa Holdings B.V. of Taurusavenue 105, 2132 LS Hoofddorp, The Netherlands

(740) Christopher, Russell Cook & Co., The Office @ 4658/A Chikwa Road, Opposite Old Magistrates Court P.O. Box 34091, Lusaka, Zambia.

(511) Int.Cl.9

(510) Software and mobile apps; computer games; computer game software; downloadable computer software for gaming, gambling, lotteries, bookmaking and betting services, whether conducted online or otherwise and including such software for mobile phones and mobile applications; downloadable virtual goods, namely, games for use online, in online virtual worlds and metaverses.

(540)



(210) 2227/2023; (220) 04.12.2023

(731) Honest Hospitality Group, LLC of 111 Town Square Place, Suite # 1203, Jersey City, NJ 07310, United States of America.

(740) Christopher, Russell Cook & Co., The Office @ 4658/A Chikwa Road, Opposite Old Magistrate Court, P.O Box 34091, Lusaka, Zambia.

(511) Int.Cl.30

(510) Prepared meals consisting primarily of rice; prepared meals consisting primarily of pasta; pizzas; freshly prepared rice dishes for consumption on or off the premises; rice; noodles; prepared noodle based meals; prepared meals consisting primarily of wheat; sandwiches; vegetable burger sandwiches; bread; foodstuffs made with flour, namely, bread rolls, naan bread, pizza crust and burger buns; foodstuffs made with corn, namely, corn chips; traditional Indian flour-based snack foods; traditional Indian rice-based snack foods; traditional Indian snack foods consisting principally of bread; traditional Indian corn-based snack foods; processed wheat; processed grains; Indian papads; spring rolls; sweetmeats; frozen yogurt confections; edible spices; pancakes; vada-pav.

(540)



-
- (210) 2246/2023; (220) 04.12.2023
- (731) Live Line Technology (Pty) Limited of 51 Connie Street, Adamayview, Klerksdorp 2570, South Africa.
- (740) Fisher, Cormack & Botha, P.O. Box 33890, Lusaka, Zambia.
- (511) Int.Cl.9
- (510) Scientific.
- (540) **LIVE LINE TECHNOLOGY DROP-OUT FUSE AND LIGHTNING ARRESTOR COMBI UNIT**
-

- (210) 2247/2023; (220) 04.12.2023
- (731) Zino Davidoff SA of Sternengasse 18, 4051, Basel, 1700, Switzerland.
- (740) Fisher, Cormack & Botha, P.O. Box 33890, Lusaka, Zambia.
- (511) Int.Cl.3
- (510) Perfumery; perfumes and toilet water; shower gels; cosmetics skin lotions; after-shave preparations; decorations and antiperspirants for personal use.
- (540)

Cool Water
REBORN

- (210) 2254/2023; (220) 05.12.2023

(731)(750)Californian Beverages Limited of Plot No. 1644 Malambo Road, P.O Box 32095, Lusaka,
Zambia.

(511) Int.Cl.32

(510) Beers; mineral and aerated waters and other non-alcoholic drinks; fruit drinks and fruit
juices; syrups and other preparations for making beverages.

(540)



(210) 2255/2023;

(220) 05.12.2024

(731)(750)Californian Beverages Limited of Plot No. 1644 Malambo Road, P.O Box 32095, Lusaka,
Zambia.

(511) Int.Cl.32

(510) Beers; mineral and aerated waters and other non-alcoholic drinks; fruit drinks and fruit
juices; syrups and other preparations for making beverages.

(540)

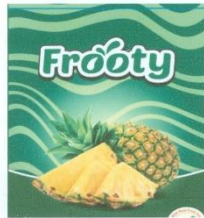

(210) 2256/2023;

(220) 05.12.2023

(731)(750)Californian Beverages Limited of Plot No. 1644 Malambo Road, P.O Box 32095, Lusaka,
Zambia.

(511) Int.Cl.32

(510) Beers; mineral and aerated waters and other non-alcoholic drinks; fruit drinks and fruit
juices; syrups and other preparations for making beverages.

(540)

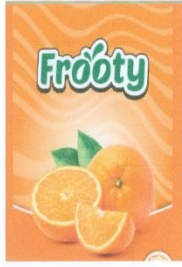

(210) 2257/2023;

(220) 05.12.2023

(731)(750)Californian Beverages Limited of Plot No. 1644 Malambo Road, P.O Box 32095, Lusaka, Zambia.

(511) Int.Cl.32

(510) Beers; mineral and aerated waters and other non-alcoholic drinks; fruit drinks and fruit juices; syrups and other preparations for making beverages.

(540)



(210) 2258/2023;

(220) 05.12.2023

(731)(750)Californian Beverages Limited of Plot No. 1644 Malambo Road, P.O Box 32095, Lusaka, Zambia.

(511) Int.Cl.32

(510) Beers; mineral and aerated waters and other non-alcoholic drinks; fruit drinks and fruit juices; syrups and other preparations for making beverages.

(540)



(210) 2259/2023; (220) 05.12.2023

(731)(750) Californian Beverages Limited of Plot No. 1644 Malambo Road, P.O Box 32095, Lusaka, Zambia.

(511) Int.Cl.32

(510) Beers; mineral and aerated waters and other non-alcoholic drinks; fruit drinks and fruit juices; syrups and other preparations for making beverages.

(540)



(210) 2271/2023; (220) 06.12.2023

(731) Namibia Dairies (Proprietary) Limited of 19 Lazarett Street, Windhoek, Namibia.

(740) Christopher, Russell Cook & Co., The Office @ 4658/A Chikwa Road, Opposite Old Magistrate Court, P.O Box 34091, Lusaka, Zambia.

(511) Int.Cl.32

(510) Beers; non-alcoholic beverages; mineral and aerated waters; fruit beverages and fruit juices; syrups and other preparations for making non-alcoholic beverages.

(540) **RIETFontein**

(210) 2272/2023; (220) 06.12.2023

- (731) Namibia Dairies (Proprietary) Limited of 19 Lazarett Street, Windhoek, Namibia.
- (740) Christopher, Russell Cook & Co., The Office @ 4658/A Chikwa Road, Opposite Old Magistrate Court, P.O Box 34091, Lusaka, Zambia.
- (511) Int.Cl.32
- (510) Beers; non-alcoholic beverages; mineral and aerated waters; fruit beverages and fruit juices; syrups and other preparations for making non-alcoholic beverages.
- (540)



-
- (210) 2273/2023; (220) 07.12.2023
- (731) Alydia Health, Inc. Of 1825 South Grant Street, San Mateo, California, 94404, United States of America.
- (740) Galloway & Co., Plot No. 11 Chabisa Road, Woodlands, Lusaka, Zambia.
- (511) Int.Cl.10
- (510) Medical apparatus and instruments for treating hemorrhage; medical devices, namely; for use in treating postpartum hemorrhage; medical devices, namely, tamponade used in the treatment of postpartum hemorrhage.
- (540) **JAIDRA**

-
- (210) 2307/2023; (220) 12.12.2023
- (731)(750) Andrew Milau Trading Limited of Shop No.210, COMESA, Lusaka, Zambia.
- (511) Int.Cl.3
- (510) Non-medicated soaps, perfumery, essential oils, non-medicated cosmetics, non-medicated hand lotions, non-medicated dentifrices.
- (540) **STAR**

- (210) 2327/2023; (220) 15.12.2023
- (731) Godrej Consumer Products Limited, of Godrej One, 4th Floor, Pirojshanagar, Eastern Express Highway, Vikhroli (East), Mumbai, 400 079, India.
- (740) Christopher, Russell Cook & Co., The Office @ 4658/A Chikwa Road, Opposite Old Magistrate Court, P.O. Box 34091, Lusaka, Zambia.
- (511) Int.Cl.3
- (510) Hair preparations and treatments, including hair colourants and dyes.
- (540)

SuperBlack

-
- (210) 2328/2023; (220) 15.12.2023
- (731) Godrej Consumer Products Limited, of Godrej One, 4th Floor, Pirojshanagar, Eastern Express Highway, Vikhroli (East), Mumbai, 400 079, India.
- (740) Christopher, Russell Cook & Co., The Office @ 4658/A Chikwa Road, Opposite Old Magistrate Court, P.O. Box 34091, Lusaka, Zambia.
- (511) Int.Cl.3
- (510) Hair preparations and treatments, including hair colourants and dyes.
- (540)

SuperBlack

-
- (210) 2356/2023; (220) 20.12.2024
- (731) Adatia Ashiq of Office 505, Building 1, Bay Square-Business Bay, P.O. Box 40334, Dubai, United Arab Emirates.
- (740) Maison Galaxy Limited, Plot No. 136, Freedomway, Lusaka.
- (511) Int.Cl.3
- (510) Cosmetics & perfumes.
- (540) **ST. LOUISE**

(210) 2359/2023; (220) 21.12.2024

(731) Colgate-Palmolive Company of 300 Park Avenue, New York, New York, NY 10022, United States of America.

(740) Christopher, Russell Cook & Co., The Office @ 4658/A Chikwa Road, Opposite Old Magistrate Court, P.O Box 34091, Lusaka, Zambia.

(511) Int.Cl.3

(510) Non-medicated toothpaste, non-medicated mouthwash, cosmetic whiteners in the nature of cosmetic teeth whitening preparations.

(540)



(210) 2360/2023; (220) 21.12.2023

(731) Colgate-Palmolive Company of 300 Park Avenue, New York, New York, NY 10022, United States of America.

(740) Christopher, Russell Cook & Co., The Office @ 4658/A Chikwa Road, Opposite Old Magistrate Court, P.O Box 34091, Lusaka, Zambia.

(511) Int.Cl.5

(510) Medicated toothpaste, medicated mouth rinse; Medicated oral care products, namely, a professional tooth whitening kit comprised primarily of medicated tooth whitening gel, and also syringes and mouth trays, for at-home use.

(540)



(210) 2381/2023; (220) 21.12.2023

(731)(750)Kalayim Investments Limited of Lot 32539/M/4 Off Lilayi Road, Lilayi, Kafue District,
Lusaka Province, Zambia.

(511) Int.Cl.29

(510) Meat, Fish, poultry, Beverages, Milk, Dried and fresh fruits, Vegetables and Other
horticultural comestible products prepared or preserved for consumption.

(540)



(210) 2393/2023; (220) 27.12.2023

(731)(750)Kwacha Payload Systems Zambia Limited of Plot No. 7691A ,Off Buluwe Road
Woodlands, Lusaka, Zambia.

(511) Int.Cl.9

(510) Scientific and technological services and research and design relating thereto; industrial
analysis and research services; computer system analysis, design and development of
computer hardware and software.

(540)



(210) 2394/2023; (220) 27.12.2023

(731) Peace Parks Foundation NPC and Khusel'Indalo South Africa NPC t/a Conservation
South Africa of 11 Termo Road, technopark, Stellenbosch, Western Cape 7613, 7613,
South Africa and 27 & 28 Austin Road, Midrand, Johannesburg, Gauteng, South Africa.

(740) Fisher, Cormack & Botha, P. O. Box 33890, Lusaka, Zambia.

(511) Int.Cl.16

(510) Paper and cardboard; printed matter; bookbinding material; photographs; stationery and office requisites, except furniture; adhesives for stationery or household purposes; drawing materials and materials for artists; paintbrushes; instructional and teaching materials; plastic sheets, films and bags for wrapping and packaging; printers' type, printing blocks.

(540)



(210) 2395/2023; (220) 27.12.2023

(731) Peace Parks Foundation NPC and Khusel'Indalo South Africa NPC t/a Conservation South Africa of 11 Termo Road, technopark, Stellenbosch, Western Cape 7613, 7613, South Africa and 27 & 28 Austin Road, Midrand, Johannesburg, Gauteng, , South Africa.

(740) Fisher, Cormack & Botha, P. O. Box 33890, Lusaka, Zambia.

(511) Int.Cl.29

(510) Meat, fish, poultry and game; meat extracts; preserved, frozen, dried and cooked fruits and vegetables; jellies, jams, compotes; eggs; milk, cheese, butter, yoghurt and other milk products; oils and fats for food.

(540)



(210) 2397/2023; (220) 27.12.2024

(731) Precision Packaging Limited of Stand No. 12621, Off Mumbwa Road, Chinika. P.O. Box 31446, Lusaka, Zambia.

(740) Christopher, Russell Cook & Co., The Office@ 4658/A Chikwa Road, Opposite Old Magistrate Court, P.O. Box 34091, Lusaka, Zambia.

(511) Int.Cl.20

(510) Containers of plastic packaging.

(540)

DairyPac

(210) 46/2024; (220) 09.01.2024

(731)(750)Roland Imperial Tobacco Company Limited of Plot Number 5751 Lufubu/Lunsemfwa Roads, Kalundu, P.O. Box 31110, Lusaka, Zambia.

(511) Int.Cl.34

(510) Tobacco; smokers' articles; matches.

(540)



(210) 47/2024; (220) 09.01.2023

(731)(750)Roland Imperial Tobacco Company Limited of Plot Number 5751 Lufubu/Lunsemfwa Roads, Kalundu, P.O. Box 31110, Lusaka, Zambia.

(511) Int.Cl.34

(510) Tobacco; smokers' articles; matches.

(540)



(210) 49/2024;

(220) 09.01.2024

(731)(750)Roland Imperial Tobacco Company Limited of Plot Number 5751 Lufubu/Lunsemfwa
Roads, Kalundu, P.O. Box 31110, Lusaka, Zambia.

(511) Int.Cl.34

(510) Tobacco; smokers' articles; matches.

(540)

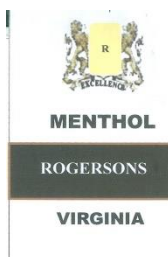

(210) 50/2024;

(220) 09.01.2024

(731)(750)Roland Imperial Tobacco Company Limited of Plot Number 5751 Lufubu/Lunsemfwa
Roads, Kalundu, P.O. Box 31110, Lusaka, Zambia.

(511) Int.Cl.34

(510) tobacco; smokers' articles; matches.

(540)



(210) 56/2024; (220) 09.01.2024

(731) Acnal Industries Private Limited of Plot No. 43, Sundareswara Nagar, Nalla Thanneer Thottam, Sivananandha Mills Road, Vilankurichi, Coimbatore-641 035, Tamil Nadu, India.

(740) Fisher, Cormack & Botha, P. O. Box 33890, Lusaka, Zambia.

(511) Int.Cl.7

(510) Centrifugal pumps including submersible, monoblock and peripheral impeller pumps, split casing, vertical turbine pumps, inline, booster, heat, circulatory, regenerative, piston, engine driven, magnetic, petroleum, drainage pumps, chemical, processing and dosing pumps, metering, peristaltic, dewatering, solar, screw, jet, self priming pumps, motors (not for land vehicles) including submersible motors, alternating current motors, direct current motors and all other motors for pumps; foot valves, check valves, actuators for valves, pumps handling chemicals and any other liquids and their spare parts, pump shafts, bushes, impellers, casing, flanges and all other pump spare parts; drip irrigation parts and equipments, sprinklers, its parts and components; ball and roller bearings, bush and thrust bearings; diesel, petrol and kerosene engines; pressure vessels for inline pumps, drill bits, DTH hammers, wet grinders, washing machines, mixie grinders.

(540)



(210) 57/2024; (220) 09.01.2024

(731) Oji Holdings Corporation of 7-5, Ginza 4-chome, Chuo-ku, Tokyo, Japan.

(740) Fisher, Cormack & Botha, P. O. Box 33890, Lusaka, Zambia.

(511) Int.Cl.5

(510) Medicines; pharmaceutical agents; pharmaceutical preparations; veterinary preparations; dietary supplements for humans; antiinflammatory agents; analgesic preparations; anticoagulants; poultices; dietetic foods adapted for medical purposes; dietary supplements for animals.

(540)



(210) 128/2024; (220) 23.01.2024

(731)(750)Airumi New Energy Zambia Limited of Farm 2112, off the T2 Road, Chibombo , Central Province, Zambia.

(511) Int.Cl.21.

(510) Cups of paper or plastic; washtubs; dustbins, garbage cans, refuse bins, trash cans; basins [receptacles].

(540)



(210) 138/2024; (220) 24.01.2024

(731)(750)Family Hardware Investment Limited of No. 31807, Nsato Road, Emmasdale, Lusaka, Zambia.

(511) Int.Cl.11

(510) Electric utensils, apparatus for lighting.

(540)



(210) 160/2024; (220) 26.01.2024

(731)(750)Byta Fm Radio Station Limited of Byta Instant Cash Limited of 119052, Town Center, Choma, Zambia.

(511) Int.Cl.9

(510) Audio- and video-receivers, audio interfaces, audio mixers, cinematographic cameras, radios, sound recording carriers, sound recording strips, sound transmitting apparatus, sound recording apparatus, sounding lines.

(540)

Byta

(210) 177/2024; (220) 29.01.2024

(731)(750)Airumi New Energy Zambia Limited of Farm 2112, off the T2 Road, Chibombo, Central Province, Zambia.

(511) Int.Cl.1

(510) Anti-frothing solutions for batteries/ant-frothing solutions for accumulators: 010251 acidulated water for recharging batteries /acidulated water for recharging accumulators.

(540)

The logo for ZAMBAT features a stylized 'Z' composed of four colored triangles (yellow, green, blue, and red) arranged in a square pattern. To the right of the 'Z' is the word 'ZAMBAT' in a bold, red, sans-serif font.

(210) 188/2024; (220) 30.01.2024

(731)(750)City Market Bakery Limited of Plot 8565, Lumumba Road, P.O. Box 38475, Lusaka, Zambia.

(511) Int.Cl.30

(510) Bread

(540) **TIPTOP**

(210) 199/2024; (220) 31.01.2024

(731)(750) Cultured Bites Investments Ltd of Plot No. 5154, Kabwe Road, Industrial Area, Ndola,
Zambia P.O Box: 71427, Lusaka, Zambia.

(511) Int.Cl.32

(510) Soft Drinks and Natural Fermented Drinks.

(540)

BRISK

(210) 201/2024; (220) 31.01.2024

(731)(750) Cultured Bites Investments Ltd of Plot No. 5154, Kabwe Road, Industrial Area, Ndola,
Zambia P.O Box: 71427, Lusaka, Zambia.

(511) Int.Cl.32

(510) Soft Drinks and Natural Fermented Drinks.

EXCEL

(540)

(210) 203/2024; (220) 01.02.2024

(731) Walmart Apollo, LLC of 702 SW 8th Street, Bentonville, Arkansas, 72716-0215, United States of America.

(740) Galloway & Co., Plot No. 11 Chabisa Road, Woodlands, Lusaka.

(511) Int.Cl.9

(510) Scientific, research, navigation, surveying, photographic, cinematographic, audiovisual, optical, weighing, measuring, signalling, detecting, testing, inspecting, life-saving and teaching apparatus and instruments; apparatus and instruments for conducting, switching, transforming, accumulating, regulating or controlling the distribution or use of electricity; apparatus and instruments for recording, transmitting, reproducing or processing sound, images or data; recorded and downloadable media, computer software, blank digital or analogue recording and storage media; mechanisms for coin-operated apparatus; cash registers, calculating devices; computers and computer peripheral devices; diving suits, divers' masks, ear plugs for divers, nose clips for divers and swimmers, gloves for divers, breathing apparatus for underwater swimming; fire-extinguishing apparatus; downloadable computer software for retail store inventory management.

(540) **SCINTILLA**

(210) 212/2024; (220) 02.02.2024

(731)(750)Medi Zam Healthcare Limited of Plot 462a, Shimabala, Kafue Road, Lusaka, Zambia.

(511) Int.Cl.10

(510) Testing apparatus for medical purposes/apparatus for use in medical analysis.

(540)



(210) 224/2024; (220) 07.02.2024

(731)(750)Swiss Bake Limited of Plot No. 29381, Nampundwe Road, off Mumbwa Road, Lusaka, Zambia.

(511) Int.Cl.30

(510) Biscuits, sweets and confectionary, coffee, tea, cocoa and artificial coffee; rice, pasta and noodles; cornflakes, tapioca and sago; soya flour and preparations made from cereals; bread, pastries; chocolate; ice cream, sugar, honey, treacle; yeast, baking powder; salt, seasonings, spices, vinegar, sauces.

(540) **SOYFUL**

(210) 225/2024; (220) 07.02.2024

(731)(750)Swiss Bake Limited of Plot No. 29381, Nampundwe Road, off Mumbwa Road, Lusaka, Zambia.

(511) Int.Cl.30

(510) Biscuits, sweets and confectionary, coffee, tea, cocoa and artificial coffee; rice, pasta and noodles; cornflakes, tapioca and sago; soya flour and preparations made from cereals; bread, pastries; chocolate; ice cream, sugar, honey, treacle; yeast, baking powder; salt, seasonings, spices, vinegar, sauces.

(540) **SUN GRAIN**

(210) 226/2024; (220) 07.02.2024

(731)(750)Swiss Bake Limited of Plot No. 29381, Nampundwe Road, off Mumbwa Road, Lusaka, Zambia.

(511) Int.Cl.32

(510) Beers; mineral and aerated waters and other non-alcoholic drinks; fruit drinks and fruit juices; rice-based and soya-based beverages; syrups and other preparations for making beverages and drinks.

(540) **SOYFUL**

(210) 227/2024; (220) 07.02.2024

(731)(750)Swiss Bake Limited of Plot No. 29381, Nampundwe Road, off Mumbwa Road, Lusaka, Zambia.

(511) Int.Cl.32

(510) Beers; mineral and aerated waters and other non-alcoholic drinks; fruit drinks and fruit juices; rice-based and soya-based beverages; syrups and other preparations for making beverages and drinks.

(540) **SUN GRAIN**

(210) 228/2024; (220) 07.02.2024

(731)(750)Parrogate Ginneries Limited of Plot No. 397/A/D, Makeni, Lusaka, Zambia.

(511) Int.Cl.16

(510) Cardboard boxes.

(540)



(210) 237/2024; (220) 09.02.2024

(731)(750)Kwacha Milling Zambia Limited of Plot No. 857912, Umodzi Highway, Industrial Area, Chipata, Zambia.

(511) Int.Cl.5

(510) Pharmaceuticals, medical and veterinary preparations ;sanitary preparations for medical purposes: dietic food and substances adapted for medical or veterinary se, food for babies; dietary supplements for humans and animals; plasters, materials for materials for dressings ;material for stopping teeth, dental wax; disinfectants; preparations for destroying vermin; fungicides, herbicides, dietary supplements, intended to supplement a normal diet or to have health benefits, meal replacements, dietic food ad beverages, adopted for medical or veterinary use.

(540)



(210) 242/2024; (220) 12.02.2024

(731)(750)Makuta Beverages Limited of Stand No. 6174, Makishi Road, Thorn Park, Lusaka, Zambia.

(511) Int.Cl.32

(510) Beers; non-alcoholic beverages; mineral and aerated waters; fruit beverages and fruit juices; syrups and other preparations for making non-alcoholic beverages, kombucha.

(540) **SPIKE**

(210) 243/2024; (220) 12.02.2024

(731)(750)Makuta Beverages Limited of Stand No. 6174, Makishi Road, Thorn Park, Lusaka, Zambia.

(511) Int.Cl.33

(510) Alcoholic beverages, except beers; alcoholic preparations for making beverages, vodka, gin, rum, whisky, ciders, spirits, liqueurs, wine.

(540) **SPIKE**

(210) 271/2024; (220) 14.02.2024

(731)(750)Acacia Food and Beverages Limited of Plot No. 8492, Njanshinshi Road, off Mumbwa Road, Chinika, P.O. Box 35879, Lusaka, Zambia.

(511) Int.Cl.32

(510) Beers; mineral and aerated waters and other non-alcoholic beverages; fruit beverages and fruit juices; syrups and other preparations for making beverages.

(540) **SNAXIT**

(210) 274/2024; (220) 14.02.2024

(731)(750)Acacia Food and Beverages Limited of Plot No. 8492, Njanshinshi Road, off Mumbwa Road, Chinika, P.O. Box 35879, Lusaka, Zambia.

(511) Int.Cl.5

(510) Pharmaceuticals, medical and veterinary preparations; sanitary preparations for medical purposes; dietetic food and substances adapted for medical or veterinary use, food for babies; dietary supplements for humans and animals; plasters, materials for dressings; material for stopping teeth, dental wax; disinfectants; preparations for destroying vermin; fungicides, herbicides.

(540) **YESS**

(210) 275/2024; (220) 14.02.2024

(731)(750)Acacia Food and Beverages Limited of Plot No. 8492, Njanshinshi Road, off Mumbwa Road, Chinika, P.O. Box 35879, Lusaka, Zambia.

(511) Int.Cl.5

(510) Pharmaceuticals, medical and veterinary preparations; sanitary preparations for medical purposes; dietetic food and substances adapted for medical or veterinary use, food for babies; dietary supplements for humans and animals; plasters, materials for dressings; material for stopping teeth, dental wax; disinfectants; preparations for destroying vermin; fungicides, herbicides.

(540) **GOFRESH**

(210) 285/2024; (220) 16.02.2024

(731)(750)Eminence Healthcare Limited of Plot No. E 12 Arusha Street Broadway, Ndola, Zambia.

(511) Int.Cl.3

(510) Bleaching preparations and other substances for laundry use; cleaning, polishing, scouring and abrasive preparations; non-medicated soaps; perfumery, essential oils, non-medicated cosmetics, non-medicated hair lotions; non-medicated dentifrices Cosmetics, (lotions, creams, petroleum jelly, and glycerine.

(540)



(210) 286/2024;

(220) 16.02.2024

(731)(750)Eminence Healthcare Limited of Plot No. E 12 Arusha Street Broadway, Ndola, Zambia.

(511) Int.Cl.3

(510) Bleaching preparations and other substances for laundry use; cleaning, polishing, scouring and abrasive preparations; non-medicated soaps; perfumery, essential oils, non-medicated cosmetics, non-medicated hair lotions; non-medicated dentifrices Cosmetics, (lotions, creams, petroleum jelly, and glycerine.

(540)



(210) 287/2024;

(220) 16.02.2024

(731)(750)Eminence Healthcare Limited of Plot No. E 12 Arusha Street Broadway, Ndola, Zambia.

(511) Int.Cl.3

(510) Bleaching preparations and other substances for laundry use; cleaning, polishing, scouring and abrasive preparations; non-medicated soaps; perfumery, essential oils, non-medicated cosmetics, non-medicated hair lotions; non-medicated dentifrices Cosmetics, (lotions, creams, petroleum jelly, and glycerine.

(540)



(210) 297/2024; (220) 19.02.2024

(731)(750)Swadesh Consumer Limited of Plot No. 748/B16, Vitanda Street, P.O Box 76004, Ndola, Zambia.

(511) Int.Cl.3

(510) Bleaching preparations and other substances for laundry use; polishing, scouring and abrasive preparations; non-medicated soaps; perfumery, essential oils, non-medicated cosmetics, non-medicated hair lotions; non-medicated dentifrices, dish washing soap.

(540) **LIMBA**

(210) 298/2024; (220) 19.02.2024

(731)(750)Swadesh Consumer Limited of Plot No. 748/B16, Vitanda Street, P.O Box 76004, Ndola, Zambia.

(511) Int.Cl.3

(510) Bleaching preparations and other substances for laundry use; polishing, scouring and abrasive preparations; non-medicated soaps; perfumery, essential oils, non-medicated cosmetics, non-medicated hair lotions; non-medicated dentifrices, dish washing soap.

(540) **ZAMB**

(210) 299/2024; (220) 19.02.2024

(731)(750)Swadesh Consumer Limited of Plot No. 748/B16, Vitanda Street, P.O Box 76004, Ndola, Zambia.

(511) Int.Cl.3

(510) Bleaching preparations and other substances for laundry use; polishing, scouring and abrasive preparations; non-medicated soaps; perfumery, essential oils, non-medicated cosmetics, non-medicated hair lotions; non-medicated dentifrices, dish washing soap.

(540) **NORREX**

(210) 300/2024; (220) 19.02.2024

(731)(750)Swadesh Consumer Limited of Plot No. 748/B16, Vitanda Street, P.O Box 76004, Ndola, Zambia.

(511) Int.Cl.3

(510) Bleaching preparations and other substances for laundry use; polishing, scouring and abrasive preparations; non-medicated soaps; perfumery, essential oils, non-medicated cosmetics, non-medicated hair lotions; non-medicated dentifrices, dish washing soap.

(540) **RICA**

(210) 301/2024; (220) 19.02.2024

(731)(750)Swadesh Consumer Limited of Plot No. 748/B16, Vitanda Street, P.O Box 76004, Ndola, Zambia.

(511) Int.Cl.3

(510) Bleaching preparations and other substances for laundry use; polishing, scouring and abrasive preparations; non-medicated soaps; perfumery, essential oils, non-medicated cosmetics, non-medicated hair lotions; non-medicated dentifrices, dish washing soap.

(540) **EZE**

(210) 302/2024; (220) 19.02.2024

(731)(750)Swadesh Consumer Limited of Plot No. 748/B16, Vitanda Street, P.O Box 76004, Ndola, Zambia.

(511) Int.Cl.3

(510) Bleaching preparations and other substances for laundry use; polishing, scouring and abrasive preparations; non-medicated soaps; perfumery, essential oils, non-medicated cosmetics, non-medicated hair lotions; non-medicated dentifrices, dish washing soap.

(540) **HOOK**

(210) 303/2024; (220) 19.02.2024

(731)(750)Swadesh Consumer Limited of Plot No. 748/B16, Vitanda Street, P.O Box 76004, Ndola, Zambia.

(511) Int.Cl.3

(510) Bleaching preparations and other substances for laundry use; polishing, scouring and abrasive preparations; non-medicated soaps; perfumery, essential oils, non-medicated cosmetics, non-medicated hair lotions; non-medicated dentifrices, dish washing soap.

(540) **FLOW**

(210) 337/2024; (220) 23.02.2024

(731)(750)UnkaGo Technologies Limited of ZCCM- IH Office Park, 16806, Alick Nkata Road, Zambia.

(511) Int.Cl.9

(510) Computer programs, downloadable; computer programs, recorded; computer software applications, downloadable; computer software platforms, recorded or downloadable; computer operating programs, recorded.

(540)



(210) 338/2024; (220) 23.02.2024

(731)(750)UnkaGo Technologies Limited of ZCCM- IH Office Park, 16806, Alick Nkata Road, Zambia.

(511) Int.Cl.16

(510) Paper and cardboard; printed matter; bookbinding material; photographs; stationery and office requisites, except furniture; adhesives for stationery or household purposes; drawing materials and materials for artists; paintbrushes; instructional and teaching materials; plastic sheets, films and bags for wrapping and packaging; printers' type, printing blocks.

(540)



(210) 339/2024; (220) 23.02.2024

(731)(750)UnkaGo Technologies Limited of ZCCM- IH Office Park, 16806, Alick Nkata Road, Zambia.

(511) Int.Cl.25

(510) Clothing, footwear and head gear.

(540)



(210) 359/2024; (220) 26.02.2024

(731)(750)The Dee Manufacturing Limited of Warehouse 12, Lamasat, Off Kafue Road, Makeni,
Lusaka, Zambia.

(511) Int.Cl.16

(510) Toilet Tissue.

(540)



(210) 401/2024; (220) 05.03.2024

(731)(750)Chiteta Chrispin Samiselo of Plot No. 229, Ibex Hill, Square One, Off Twin Palm Road,
Lusaka, Zambia.

(511) Int.Cl.16

(510) Paper and cardboard; printed matter; bookbinding material; photographs;.

(540)



STATUTORY NOTICES UNDER THE TRADE MARKS ACT (CAP. 401)

ACCEPTED APPLICATIONS FOR REGISTRATION OF TRADE MARKS - CONDITIONAL. (BB/CA)

NOTICE IS HEREBY GIVEN, that any person who has ground of opposition to registration of the following trade marks may, within two months of the date of publication hereof, file a notice of opposition on Form T.M. No. 6 with the Registrar of Trade Marks, Zambia Patent Office.

Preferably, any objector must file the notice of opposition only after writing the applicant to give him reasonable notice about the intended opposition in order to afford him an opportunity of withdrawing his application. Failure to do this will be taken into account in considering any application by any party for an order for costs if the opposition is uncontested by the applicant. A letter B, C, or D prefixed to the application number means that the application is for registration, respectively, in Part B, C (certification mark) or D (defensive mark) of the register of trade marks. If an application proceeds in Part A, the application number is unaccompanied by any letter.

(210) 1371/2017;

(220) 23.08.2017

(731) Pearl Dairy Farms Ltd, Migamba village, nyakinengo ward, biharwe division, mbarara, Uganda.

(740) Christopher Russell Cook & Co., The Office @ 4658/A Chikwa Road, Opposite Old Magistrates Court, P.o. Box 34091, Lusaka, Zambia.

(511) Int.Cl.29.

(510) Milk and milk products; edible oils and fats.

(526) Registration of this mark shall give no exclusive right to the use of the word 'Milk' separately and apart from the mark as a whole.

(540)



(210) 1072/2022;

(220) 20.07.2022

(731) Debonairs Pizza (Proprietary) Limited of 478 James Crescent, Midrand, Gauteng, South Africa.

(740) Fisher, Cormack & Botha, P.o. Box 33890, Lusaka, Zambia.

(511) Int.Cl.30.

(510) Coffee, tea, cocoa and artificial coffee;rice, pasta and noodles;flour and preparations made from cereals;bread, pastries and confectionery;pizzas, sandwiches, pies;prepared meals and ready-to-eat meals;chocolate;ice cream, sorbets and other edible ices; salt, seasonings, spices, vinegar, sauces and other condiments.

(526) Registration of this trade mark shall give no exclusive right to the use of the term 'DELIVERY' separately and apart from the mark as a whole.

(540)



(210) 1364/2023; (220) 21.08.2023

(731) Akila Trading (Proprietary) Limited, of 857 Voortrekker Road, Maitland, 7405, Western Cape, South Africa

(740) Christopher Russell Cook & Co., The Office @ 4658/A Chikwa Road, Opposite Old Magistrates Court P.o. Box 34091, Lusaka, Zambia.

(511) Int.Cl. 5

(510) Dietetic food and substances adapted for medical or veterinary use, food for babies; dietary supplements for human beings and animals.

(526) Registration of this trade mark shall give no right to the exclusive use of the 'WORLD MAP' as such, each separately other than as applied in the mark as a whole.

(540)



(210) 1365/2023; (220) 21.08.2023

- (731) Akila Trading (Proprietary) Limited of 857 Voortrekker Road, Maitland, 7405, Western Cape, South Africa
- (740) Christopher Russell Cook & Co., The Office @ 4658/A Chikwa Road, Opposite Old Magistrates Court P.o. Box 34091, Lusaka, Zambia.
- (511) Int.Cl.29
- (510) Meat, fish, poultry and game; meat extracts; preserved, frozen, dried and cooked fruits and vegetables; jellies, jams, compotes; eggs; milk, cheese, butter, yogurt and milk products; oils and fats for food ; beans, pulses; nuts; lentils; processed peas.
- (526) Registration of this trade mark shall give no right to the exclusive use of the 'Map of Africa', as such, each separately other than as applied in the mark as a whole.
- (540)



-
- (210) 1366/2023; (220) 21.08.2023
- (731) Akila Trading (Proprietary) Limited of 857 Voortrekker Road, Maitland, 7405, Western Cape, South Africa.
- (740) Christopher Russell Cook & Co., The Office @ 4658/A Chikwa Road, Opposite Old Magistrates Court P.O. Box 34091, Lusaka, Zambia.
- (511) Int.Cl. 30
- (510) Coffee, tea, cocoa and substitutes therefor; rice; pasta and noodles; tapioca and sago; flour and preparations made from cereals; bread, pastries and confectionery; chocolate; ice cream, sorbets and other edible ices; sugar, honey, treacle; yeast, baking-powder; salt; seasonings spices; preserved herbs, vinegar, sauces and other (condiments); ice(frozen water); corn starch; popcorn.
- (526) Registration of this trade mark shall give no right to the exclusive use of the 'World Map', as such, each separately other than as applied in the mark as a whole.
- (540)



(210) 1367/2023;

(220) 21.08.2023

(731)(750) Akila Trading (Proprietary) Limited of 857 Voortrekker Road, Maitland, 7405, Western Cape, South Africa.

(740) Christopher Russell Cook & Co., The Office @ 4658/A Chikwa Road, Opposite Old Magistrates Court P.O. Box 34091, Lusaka Zambia.

(511) Int.Cl. 32

(510) Beers; non-alcoholic beverages; mineral and aerated waters; fruit beverages and fruit juices; syrups and other preparations for making non-alcoholic beverages.

(526) Registration of this trade mark shall give no right to the exclusive use of the 'World Map', as such, each separately other than as applied in the mark as a whole.

(540)



(210) 1694/2023;

(220) 06.10.2023

(731)(750) Musa Biscuits Limited of Plot No. 22836 Nampundwe Road, Lusaka, Zambia.

(511) Int.Cl.30

(510) Biscuits.

(526) The trademark consists of the words Amama Biscuits (Vanilla Flavour) while the rest of the wording is non trademark matter.

(540)



- (210) 1978/2023; (220) 31.10.2023
(310) 2023/19150; (320) 13.07.2023; (330) ZA
(731) Dynamic Brands Manufacturing (PTY) LTD of 2 Adelaide Rd, Gately Extension, East London, 5201, South Africa.
(740) Galloway & Co., Plot No. 11 Chabisa Road, Woodlands, Lusaka, Zambia.
(511) Int.Cl.29
(510) Meat, fish, poultry and game; meat extracts; preserved, frozen, dried and cooked fruits and vegetables; jellies, jams, compotes; eggs; milk, cheese, butter, yoghurt and other milk products; oils and fats for food.
(526) Registration of this trade mark shall give no exclusive right to the use of the word 'BURST' except as shown in the trade mark as a whole.
(540) **DAIRY BURST**
-

- (210) 2197/2023; (220) 28.11.2023
(731) Chevron Intellectual Property LLC of 6001 Bollinger Canyon Road, San Ramon, California 94583, United States of America.
(740) Fisher, Cormack & Botha P.o. Box 33890, Lusaka, Zambia.
(511) Int.Cl. 4
(510) Lubricating oils and greases; petroleum and petroleum products.
(526) Registration of this trade mark shall give no exclusive right to the use of the letters 'G' 'S' 'T', separately apart from the mark as a whole.
(540) **GST**
-

- (210) 2202/2023; (220) 29.11.2023
(731) (750) Parrogate Ginneries Limited Plot No. 397/A/D, Makeni, Lusaka, Zambia.
(511) Int Cl. 16
(510) Cardboard Boxes.

(526) The trade mark subsists in the word 'WHITE GOLD', while the rest of the wording is descriptive and therefore non-trade mark matter.

(540)



(210) 2203/2023; (220) 29.11.2023.

(731) (750) Parrogate Ginneries Limited Plot No. 397/A/D, Makeni, Lusaka, Zambia.

(511) Int Cl. 16

(510) Cardboard Boxes.

(526) The trade mark subsists in the word 'Zamanita', while the rest of the wording is descriptive and therefore non-trade mark matter.

(540)



(210)2300/2023; (220) 12.12.2023

(731)(750) Sha & Sha Products Limited of Plot No. 9295, Njolwe Road, Industrial Area, Lusaka , Zambia.

(511) Int.Cl. 29

(510) Peanut Butter.

(526) Trademark rights subsist in the words 'EVERYDAY' and the get up while the rest are non-trademark matter are disclaimed.

(540)



(210) 2301/2023; (220) 12.12.2023

(731)(750) Assitou Le Rose Enterprises Limited of Plot No. 10, Woodlands, Lusaka, Zambia.

(511) Int.Cl.29

(510) Peanut Butter.

(526) The trade mark subsists in the word 'TAONGA' and the get-up, while the rest of the wording is descriptive and non-trade mark matter.

(566) Applicant submits the word 'TAONGA' is a vernacular term in Tumbuka meaning 'THANK YOU'.

(540)



(210) 2367/2023; (220) 21.12.2023

(731) Gocongo Enterprises of SARLU-RCCM 13B1024, Congo.

(740) Musa Dudhia & Company Plot 1394, Mushemi road, Rhodespark, Lusaka, Zambia.

(511) Int.Cl. 30

(510) Biscuits.

(526) The following Conditions apply: Proceeding in terms of Section 23(1)

(540)



- (210) 2369/2023; (220) 21.12.2023
- (731) Gocongo Enterprises of SARLU-RCCM 13B1024, Congo.
- (740) Musa Dudhia & Company, Plot 1394, Mushemi Road, Rhodes Park, Lusaka, Zambia.
- (511) Int.Cl.30
- (510) Maize meal.
- (526) Registration of this trademark shall give no exclusive right to the 'MAIZE COB DEVICE' separately apart from the mark as a whole.
- (566) Applicant submits that the words "KILA SIKU" mean every single day in Swahili.



(540)

-
- (210) 2376/2023; (220) 21.12.2023
- (731) NGM International BV of Willemsplein 492, 3016 DR Rotterdam, Netherlands.
- (740) Eric Silwamba, Jalasi & Linyama Legal Practitioners No.12 Chilekwa Mwamba Road, Off Lubu/Saise Roads, Longacres, Lusaka, Zambia.
- (511) Int.Cl.29
- (510) Meat, fish, poultry and game; meat extracts; preserved, frozen, dried and cooked fruits and vegetables; jellies, jams, compotes; eggs; milk, cheese, butter, yogurt and other milk products; oils and fats for food.
- (526) Registration of this mark shall give no exclusive right to the use of the phrase 'QUALITY FOOD' separately apart from the mark as whole.
- (540)



-
- (210) 2377/2023; (220) 21.12.2023
- (731) NGM International BV of Willemsplein 492, 3016 DR Rotterdam, Netherlands
- (740) Eric Silwamba, Jalasi & Linyama Legal Practitioners No.12 Chilekwa Mwamba Road, Off Lubu/Saise Roads, Longacres, Lusaka, Zambia.

(511) Int.Cl. 30

(510) Coffee, tea, cocoa and substitutes therefor; rice, pasta and noodles; tapioca and sago; flour and preparations made from cereals; bread, pastries and confectionery; chocolate; ice cream, sorbets and other edible ices; sugar, honey, treacle; yeast, baking-powder; salt, seasonings, spices, preserved herbs; vinegar, sauces and other condiments; ice (frozen water).

(526) Registration of this mark shall give no exclusive right to the use of the phrase 'QUALITY FOOD' separately apart from the mark as whole.

(540)



(210) 2383/2023;

(220) 22.12.2023

(731)(750) Gildez Wine Manufacturing Limited of Plot 396A/14/1, Makeni, Lusaka, Zambia.

(511) Int.Cl.33

(510) Wine.

(526) The trade mark subsists in the words 'GILDEZ CHOICE' and the getup, while the rest of the wording and pictorial representations are descriptive and therefore non-trade mark matter.

(540)



(210) 1/2024;

(220) 02.01.2024

(731)(750) Unicorn Industries Limited of Plot No. 4787, Mungwi Road, Heavy Industrial, Lusaka, Zambia.

(511) Int.Cl.33

(510) Vodka and alcoholic beverages.

(526) Registration of this trademark shall give no exclusive right to the use of the word "Vodka" separately apart from the mark.

(540) **BOUNCER VODKA**

(210) 2/2024; (220) 02.01.2024

(731)(750) Unicorn Industries Limited of Plot No. 4787, Mungwi Road, Heavy Industrial, Lusaka, Zambia.

(511) Int.Cl.33

(510) Vodka and alcoholic beverages.

(526) Registration of this trademark shall give exclusive right to the use of the word "wine" separately apart from the mark.

(540) **ADAM'S WINE**

(210) 208/2024; (220) 01.02.2024

(731)(750) Unicorn Industries Ltd of Plot No. 4787, Mungwi Road, Heavy Industrial, Lusaka, Zambia.

(511) Int.Cl.32

(510) Mineral water.

(526) Registration of this trade mark shall give no exclusive right to the use of the words 'PURE DRINKING WATER' except as shown in the trade mark as a whole.

(540) **HYDROCUBE PURE Drinking WATER**

(210) 216/2024; (220) 06.02.2024

(731)(750) Al Mansour International Distribution Company of Zahraa El Maadi-Industrial Zone, P.O Box 97-New Maadi, Cairo, Egypt.

(511) Int.Cl.34

(510) Tobacco; smokers' articles; matches.

(526) Registration of this trade mark shall give no exclusive right to the use, separately, of the word 'MENTHOL', other than as it appears wholly together as a trade mark.

(540)



(210) 229/2024; (220) 08.02.2024

(731)(750) Tobacco Board of Zambia of Plot No. 19288, Mungwi road, Zambia.

(511) Int.Cl.16

(510) Stationary, letterheads, business cards, brochures, printed promotional materials.

(526) Registration of this trademark shall give no exclusive right to the use of the word Zambia separately, apart from the mark.



(540)

(210) 232/2024; (220) 08.02.2024

(731)(750) Kwacha Milling Zambia Limited Of Plot No. 857912, Umodzi Highway, Industrial Area, Chipata, Zambia.

(511) Int.Cl.5

(510) Pharmaceuticals, medical and veterinary preparations ;sanitary preparations for medical purposes: dietic food and substances adapted for medical or veterinary se, food for babies; dietary supplements for humans and animals; plasters, materials for materials for dressings ;material for stopping teeth, dental wax; disinfectants; preparations for destroying vermin; fungicides, herbicides, dietary supplements, intended to supplement a normal diet or to have health benefits, meal replacements, dietic food ad beverages, adopted for medical or veterinary use.

(526) The mark consists of the words Power Nutritional meal while the rest of the wording is descriptive and non-trademark matter.

(540)

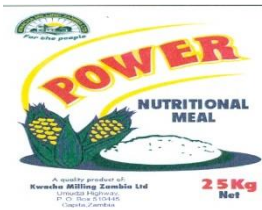

(210) 239/2024;

(220) 12.02.2024

(731)(750) Khushee Investments Ltd of Plot No:- 10936, Off Mukatasha Road, Chinika Industrial Area, Lusaka, Zambia.

(511) Int.Cl.31

(510) Raw and unprocessed agricultural, aquacultural, horticultural and forestry products; raw and unprocessed grains and seeds; fresh fruits and vegetables, fresh herbs; natural plants and flowers; bulbs, seedlings and seeds for planting; live animals; foodstuffs and beverages for animals; malt.

(526) Registration of this trade mark shall give no exclusive right to the use of the term 'MADE IN INDIA' each separately and apart from the mark as a whole.

(540)

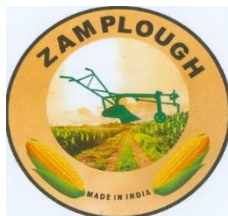

(210) 260/2024;

(220) 12.02.2024

(731)(750) SWISS BAKE LIMITED of Plot No. 29381, Nampundwe Road, Light Industrial Area P.O Box 30824, Lusaka, Zambia.

(511) Int.Cl.30

(510) Biscuits, sweets and confectionary, coffee, tea, cocoa and artificial coffee; rice, pasta and noodles; cornflakes, tapioca and sago; soya flour, soya chunks and preparations made from cereals; bread, pastries; chocolate; ice cream, sugar, honey, treacle; yeast, baking powder; salt, seasonings, spices, vinegar, sauces.

(526) Registration of this trade mark shall give no exclusive right to the use of the word 'GRAIN', separately apart from the mark as a whole.

(540)



(210) 266/2024;

(220) 13.02.2024

(731)(750) Gourock Zambia Limited of Stand No. E-12, Arusha Street, Copperbelt Province, P.O Box 70467, Ndola, Zambia.

(511) Int.Cl.29

(510) Oil for food category, cooking oil-vegetable oil.

(526) Registration of this mark, will not give exclusive rights to the use of the words 'Cooking Oil' and 'Vegetable Oil' apart from the mark as a whole.

(566) Moyo Wa Simba - It is a swahili word meaning - Heart of Liom Mafuta Ya Kupikiya - It is a swahili word meaning - Cooking Oil ; Huile Vegetale - It is a French word meaning - Vegetable oil

(540)



(210) 284/2024;

(220) 16.02.2024

(731)(750)Eminence Healthcare Limited of Plot No. E 12 Arusha Street Broadway, Ndola, Zambia.

(511) Int.Cl.3

(510) Bleaching preparations and other substances for laundry use; cleaning, polishing, scouring and abrasive preparations; non-medicated soaps; perfumery, essential oils, non-medicated cosmetics, non-medicated hair lotions; non-medicated dentifrices Cosmetics, (lotions, creams, petroleum jelly, and glycerine.

(526) Registration of this trademark shall give no exclusive right to the word 'Lavish' seperately apart from the mark as a whole.

(540)



(210) 321/2024;

(220) 21.02.2024

(731)(750) Kvc Industries Limited of Plot No. 1344, Industrial Area, Ndola, Zambia.

(511) Int.Cl.33

(510) Pineapple flavored Whisky.

(526) Registration of this trademark shall give no exclusive right to the use of the word 'whisky' seperately apart from the mark.

(540)



(210) 360/2024;

(220) 26.02.2024

(731)(750) Nedypronas Trading Limited of Plot No. 20839, Chinika Industrial area, engen filing station premises, along mumbwa road, Lusaka, Zambia.

(511) Int.Cl.1

(510) Chlorine.

(526) The trade mark subsists in the words 'NAIL TOP' and the get-up, while the resting of the wording is descriptive and therefore non trade mark matter.

(540)



(210) 402/2024; (220) 05.03.2024

(731)(750) Breton Investments Limited of Plot No. 151, Chelstone Green, Lusaka, Zambia.

(511) Int.Cl.32

(510) Beers; mineral and aerated waters and other non-alcoholic beverages; fruit beverages and fruit juices; syrups and other preparations for Making beverages.

(526) Trademark rights subsist in the words MEYADROPS and the get up of the mark while the other words are disclaimed.

(540)



STATUTORY NOTICES UNDER THE TRADE MARKS ACT (CAP. 401)

TRADE MARK APPLICATIONS ADVERTISED BEFORE ACCEPTANCE. (CA)

(210) 1312/2023; (220) 11.08.2023

(731) Interpack Consumable Manufacturers cc of PTN 32/5 Dobra, Windhoek, Namibia.

(740) Christopher Russell Cook & Co., The Office @ 4658/A Chikwa Road, Opposite Old Magistrates Court, P.O. Box 34091, Lusaka

(511) Int.Cl.32

(510) Fruit Juices

(540)



(210) 240/2024; (220) 12.02.2024

(731)(750) Makuta Beverages Limited of Stand No. 6174, Makishi Road, Thorn Park, Lusaka, Zambia.

(511) Int.Cl.32

(510) Beers; non-alcoholic beverages; mineral and aerated waters; fruit beverages and fruit juices; syrups and other preparations for making non-alcoholic beverages, kombucha.

(526) To be advertised before acceptance pursuant to Section 23 (1) proviso of the Trade Marks Act.

(540) **ICEBERG**

(210) 241/2024; (220) 12.02.2024

(731)(750) Makuta Beverages Limited of Stand No. 6174, Makishi Road, Thorn Park, Lusaka, Zambia.

(511) Int.Cl.33

(510) Alcoholic beverages, except beers; alcoholic preparations for making beverages, vodka, gin, rum, whisky, ciders, spirits, liqueurs, wine.

(526) To be advertised before acceptance pursuant to Section 23 (1) proviso of the Trade Marks Act.

(540) **ICEBERG**

STATUTORY NOTICES UNDER MADRID

ACCEPTED TRADE MARK APPLICATIONS FILED FOR REGISTRATION UNDER THE MADRID PROTOCOL FOR THE REGISTRATION OF INTERNATIONAL MARKS.(CA)

(210) 17755668;

(220) 14.07.2023

(731) Hanwha Corporation 86, Cheonggyecheon-ro, Jung-gu Seoul, Republic of Korea

(511) Int.Cl. 13

(510) Detonators; detonating caps, other than toys; shell fuses; electronic explosive caps; industrial detonating caps, other than toys; primers for explosives; non-electric blasting caps, other than toys; electric blasting caps, other than toys; electronic detonating caps, other than toys.

(540) **HiTRONIC**

Note: Opposition period for this trademark expires on **12.10.2024**

(210) 1755566;

(220) 02.08.2023

(731) Guangzhou Helioson Car Care Co., Ltd. No. 8 Longdong Road, High Tech Industrial Park, Economic Development Zone of Conghua 510000 Guangdong , China

(511) Int.Cl. 3

(510) Starch glaze for laundry purposes; polishing preparations; polishing wax; detergents for leather; grinding preparations; polishing powder; automobile polish; scouring preparations.

(540) 

Note: Opposition period for this trademark expires on **12.10.2024**

(210) 1755536;

(220) 11.07.2023

(731) Anglo American Woodsmith Limited, 17 Charterhouse Street, London EC1N 6RA , United Kingdom

(511) Int.Cl. 1

(510): Chemicals and chemical products for use in industry, mining, science and photography, agriculture, horticulture and forestry; industrial minerals; fertilisers; polyhalite; nitrogenous fertilisers; phosphates namely phosphatic fertilizers, zinc phosphates,

copper phosphates; superphosphates namely superphosphate fertilizers; organic fertilisers; liquid fertilisers; potassium based fertilisers; dry blended fertilisers; multi-nutrient fertilisers; hydrated sulphate.

(540) **ALDOR**

Note: Opposition period for this trademark expires on **12.10.2024**

(210) 17755086;

(220) 03.07.2023

(731) LONGi Green Energy Technology Co., Ltd. No. 388 Middle Hangtian Road, Chang'an District, Xi'an Shaanxi, China

(511) Int.Cl 9

(510) Solar batteries; solar panels for the production of electricity; photovoltaic cells; junction boxes [electricity]; connectors [electricity]; materials for electricity mains [wires, cables]; wire connectors [electricity]; battery boxes; accumulator boxes; battery chargers; battery jars; accumulator jars; accumulators, electric; inverters [electricity]; converters, electric; collectors, electric; couplings, electric; connections, electric; ionization apparatus not for the treatment of air or water; solar wafers; crystalline silicon solar cells; solar cell module; photovoltaic installations and equipment for solar power generation; solar powered charger; photovoltaic inverters; photovoltaic power generation equipment; photovoltaic panel; capacitors

(540) **Hi-MO**

Note: Opposition period for this trademark expires on **12.10.2024**

(210) 1755096;

(220) 12.07.2023

(731) BOGAP Inc. Floor 1-2, Building 4, No. 1628 Lizheng Road, Lingang New Area China (Shanghai) Pilot Free Trade Zone , China

(511) Int.Cl. 7, 12

(510):**07** Filters for cleaning cooling air, for engines; injectors for engines; joints [parts of engines]; cylinder heads for engines; exhausts for motors and engines; pumps [parts of machines, engines or motors]; taps [parts of machines, engines or motors]; pneumatic

controls for machines, motors and engines; connecting rods for machines, motors and engines.

12 Cars; axle bearings for land vehicles; engines for land vehicles; shock absorbers for automobiles; gear boxes for land vehicles; connecting rods for land vehicles, other than parts of motors and engines; transmission shafts for land vehicles; engine mounts for land vehicles; brake pads for automobiles; transmission chains for land vehicles; freewheels for land vehicles; propulsion mechanisms for land vehicles; drive chains for land vehicles.

(540) **BOGAP//4**

Note: Opposition period for this trademark expires on **12.10.2024**

(210) 1755110;

(220) 03.07.2023

(731) Guangdong Wei Shi Technology Co., LTD Room 301, Building 1, Jichengkechuang Park, No. 25 of Sanle East Road, Shunjiang Community, Beijiao Town, Shunde District, Foshan City 528300 Guangdong Province, China

(511) Int.Cl. 9, 11

(510):**09** Computer programs, downloadable; scales; cases for smartphones; headset; cameras [photography]; USB cable; protection devices for personal use against accidents; biometric fingerprint lock; eyeglasses; batteries, electric.

11 Light bulbs; electric cooktops; freezers; air-conditioning installations; air conditioning equipment; hot air apparatus; fountains; hot air bath fittings; water purifying apparatus and machines; polymerisation installations.

(540) **VSTI**

Note: Opposition period for this trademark expires on **12.07.2024**

(210) 1755165;

(220) 30.05.2023

(731) Euro Games Technology Ltd. 4, "Maritsa" Str., "Vranya-Lozen-Triugulnika" BG-1151 Sofia, Bulgaria

(511) Int.Cl. 9, 28

(510):

09 Software; computer gaming software; computer software packages; computer operating system software; computer software, recorded; software drivers; virtual reality software; games software; entertainment software for computer games; computer programs for network management; operating computer software for main frame computers; monitors (computer hardware); computer hardware; apparatus for recording images; monitors (computer programs); computer game programs; computer programs for recorded games; apparatus for recording, transmission or reproduction of sound or images; communications servers [computer hardware]; electronic components for gambling machines; computer application software featuring games and gaming; computer software for the administration of on-line games and gaming; computer hardware for games and gaming; computer hardware and software for gambling, gambling machines, gambling games on the Internet and via telecommunication network.

28 Gaming machines for gambling; chips for gambling; mah-jong; arcade games; gambling machines operating with coins, notes and cards; games; electronic games; parlor games; gaming chips; gaming tables; slot machines [gaming machines]; LCD game machines; slot machines and gaming devices; coin-operated amusement machines; roulette chips; poker chips; chips and dice [gaming equipment]; gaming equipment for casinos; roulette tables; gaming roulette wheels; casino games; amusement and gambling machines; coin-operated gaming machines and / or electronic coin-operated gaming machines with or without the possibility of gain; boxes for coin-operated machines, slot machines and gaming machines; electronic or electrotechnical gaming devices, amusement and gaming machines, including coin-operated machines; housings for coin-operated machines, gaming equipment, gaming machines, machines for gambling; electropneumatic and electrical gambling machines (slot machines).

(540) The logo for 'SUPER COLLECTION 1' features the word 'SUPER' in a small, red, sans-serif font above the word 'COLLECTION' in a larger, bold, red, sans-serif font. The number '1' is positioned to the right of 'COLLECTION' in a large, bold, red, sans-serif font. The entire logo has a slight 3D effect with a dark red shadow.

Note: Opposition period for this trademark expires on **12.10.2024**

(210) 1755269;

(220) 12.09.2023

(731) Apple Inc. One Apple Park Way, Cupertino CA 95014, United States of America

(511) Int.Cl. 9

(510) Downloadable file-sharing software; downloadable computer software for the transmission and sharing of data, information, and images; application development software.

(540) **NAMEDROP**

Note: Opposition period for this trademark expires on **12.10.2024**

(210) 1755272; (220) 02.08.2023

(731) Yiwu Qinyan Cosmetics Co., Ltd, 1 / F, Building 8, 168 Chouyi West Road, Yiting Town, Yiwu City, Jinhua City, 322000 Zhejiang Province, China

(511) Int.Cl. 3

(510) Bath lotion; shampoos; cleaning preparations; polishing preparations; abrasives; perfumes; cosmetics; dentifrices; potpourris [fragrances]; air fragrancing preparations.

(540) **CLIVE DORRIS**

Note: Opposition period for this trademark expires on **12.10.2024**

(210) 1755304; (220) 18.05.2023

(731) Euro Games Technology Ltd. 4, "Maritsa" Str., "Vranya-Lozen-Triugulnika" BG-1151 Sofia, Bulgaria

(511) Int.Cl. 9, 28

(510):

09 Software; computer gaming software; computer software packages; computer operating system software; computer software, recorded; software drivers; virtual reality software; games software; entertainment software for computer games; computer programs for network management; operating computer software for main frame computers; monitors (computer hardware); computer hardware; apparatus for recording images; monitors (computer programs); computer game programs; computer programs for recorded games; apparatus for recording, transmission or reproduction of sound or images; communications servers [computer hardware]; electronic components for gambling machines; computer application software featuring games and gaming; computer software for the administration of on-line games and gaming; computer hardware for games and gaming; computer hardware and software for gambling, gambling machines, gambling games on the Internet and via telecommunication network.

28 Gaming machines for gambling; chips for gambling; mah-jong; arcade games; gambling machines operating with coins, notes and cards; games; electronic games; parlor games;

gaming chips; gaming tables; slot machines [gaming machines]; LCD game machines; slot machines and gaming devices; coin-operated amusement machines; roulette chips; poker chips; chips and dice [gaming equipment]; gaming equipment for casinos; roulette tables; gaming roulette wheels; casino games; amusement and gambling machines; coin-operated gaming machines and / or electronic coin-operated gaming machines with or without the possibility of gain; boxes for coin-operated machines, slot machines and gaming machines; electronic or electrotechnical gaming devices, amusement and gaming machines, including coin-operated machines; housings for coin-operated machines, gaming equipment, gaming machines, machines for gambling; electropneumatic and electrical gambling machines (slot machines).

(540) **Rainbow Hot**

Note: Opposition period for this trademark expires on **12.10.2024**

(210) 1755400;

(220) 15.11.2023

(731) Atlas Copco Airpower, NV Boomsesteenweg 957 B-2610 Wilrijk , Belgium

(511) Int.Cl. 7

(510) Power tools; power actuated tools; portable power operated machine tools and tools therefor; apparatus for compressing air; compressors; air compressors; gas compressors; mobile compressors; electric compressors; high pressure compressors; diesel air compressors; piston compressors; power generators; generators; gas generators; electric machine motors; engines for machine operations; electric drills and drilling machines; pneumatic drills; tool holders for machines; tool ejectors for machines; power operated hammers and tools therefor; machine tools for drilling; parts, fittings and accessories for all the aforesaid goods..

(540) **E-AIR**

Note: Opposition period for this trademark expires on **12.10.2024**

(210) 1743839;

(220) 29.03.2023

(731) MOTUL, 119 boulevard Félix Faure F-93300 Aubervilliers, France

(511) Int.Cl. 01, 03, 04, 05

(510):

01 Chemical products for cooling liquids, chemical products as ingredients for the composition of lubricants; chemical additives to motor fuel; chemical products for use in

industry, science, photography, as well as in agriculture, horticulture and forestry; unprocessed artificial resins, unprocessed plastics; soil fertilizers; fire-extinguishing compositions; tempering and soldering preparations; chemical substances for preserving foodstuffs; tanning materials; adhesives for use in industry; products for waterproofing (chemical products), anti-freeze, chemical scale-removing products (other than for household use).

03 Cosmetic products for skin care (not for medical use); brightening soaps; cleaning products for bikers (for human use) and cleaning products for their equipment (helmets, clothing, motorcycles); creams for leather or imitation leather, products for preserving leather or imitation leather (polishes); polishing creams, polishing preparations; detergents and degreasing products other than those used during manufacturing processes; stain removers, cleaning oils; preparations for shining vehicle surfaces; rust removing products; shining products [polish]; cleaning preparations for mechanical parts, chains, bodies, air filters and other parts of motorcycles; wheel rim cleaners, motorcycle seat cleaners, helmet and visor cleaners, chrome and aluminum cleaners, motorcycle fairing cleaners, surface cleaners; cleaning preparations for dull surfaces.

04 Industrial oils and greases; lubricants; oils, greases and lubricants for vehicle motors and engines; non-chemical additives to motor fuel; dust absorbing, wetting and binding compositions, for use in the maintenance of vehicle motors and engines and all machine motors and engines; fuels (including motor spirit) and illuminants; candles, wicks for lighting; compositions used as binding agents for fuels, dust binders, fork oils.

05 Disinfectant soaps.

(540) The logo consists of the word "MOTUL" in a large, bold, sans-serif font, followed by the slogan "WE ADD MILES TO LIFE" in a smaller, all-caps, sans-serif font. The text is white and set against a dark, rectangular background.

Note: Opposition period for this trademark expires on **03.08.2024**

(210) 1756063;

(220) 17.05.2023

(731) Huawei Technologies Co., Ltd. Administration Building Huawei Technologies Co., Ltd.
Bantian, Longgang District Shenzhen, China

(511) Int.Cl. 1, 2, 4, 6, 7, 8, 11, 14, 16, 17, 18, 24, 25, 27, 28

(510):

01 Brake fluid; chemical additives to motor fuel; antifreeze; automatic transmission fluids; de-icing fluids; urea solution for automobile exhaust; carbon for filters; catalysts; paste fillers for automobile body repair; hydraulic brake fluid.

02 Undersealing for vehicle chassis; undercoating for vehicle chassis; transparent protective coatings [paints] for vehicle; paints for automobile; spray paints; paints for the manufacture of automobile; anti-rust preparations coatings [paints] for vehicles; anti-corrosive paints; flame retardant paints; anti-rust greases.

04 Motor oil; non-chemical additives for motor oil; lubricating grease for automobiles; lubricating oil; motor fuel; fuel; belting wax; industrial wax; dust removing preparations; electrical energy.

06 Ironmongery; wheel clamps (boots); locks of metal for vehicles; badges of metal for automobiles; badges of metal for vehicles; safes, electronic; flanges of metal (collars); containers of metal (storage, transport); works of art of common metal.

07 Starters for motors and engines; alternators; cooling radiators for automobile motors; intake air filter for automobile engines; clutches for machines; control mechanisms for machines, engines or motors; bearings for machines; bearings for engines; fly-wheels for automobile motors; oil pump for automobiles; washing machines (laundry); machines for the electronics industry; mixing machines; electric juicers; ironing machines; kitchen machines, electric; dishwashers for household purposes; hydraulic controls for machines, motors and engines; hydraulic oil filter; washing installations for vehicles; machines and apparatus for cleaning, electric; wireless vacuum cleaners; rechargeable sweepers.

08 Hand tools, hand-operated; hand implements for hair curling; depilation appliances, electric and non-electric; hair straightener, electric; beard clippers; manicure sets; graving tools (hand tools); can openers, non-electric; table knives, forks and spoons for babies; tableware (knives, forks and spoons).

11 Coffee machines, electric; microwave ovens (cooking apparatus); bread baking machines; kettles, electric; induction cookers; electric rice cookers; air fryers; electric coffee makers; soya milk making machines, electric; refrigerators; cooling installations for liquids; air purifiers; humidifiers for household purposes; air dryers; anion generating humidifiers; extractor hoods for kitchens; air conditioning installations for vehicles; heaters for vehicles; defrosters for automobiles; garment steamers; preheaters for automobile motors; air conditioners for vehicles; defrosters for vehicles; air filtering installations; air purifying apparatus and machines; automatic water faucets; heaters for baths; bath lamps for heating; electric hot air hand dryers; whirlpool-jet apparatus; electric water purifiers for household purposes; drinking fountain; brake lights for vehicles; lights for vehicle generators; headlights for automobiles; lamps; lighting apparatus for vehicles; anti-glare devices for vehicles (lamp fittings); vehicle reflectors; hair dryers.

14 Jewellery boxes; jewellery findings; charms for key rings; jewellery chains; straps for wristwatches; watch bands; watch cases (parts of watches); wristwatches; watches; alarm clocks.

16 Albums; tracing patterns; note books; charts; drawing instruments; passport holders of leather.

17 Rubber, raw or semi-worked; clutch linings; gaskets; fittings, not of metal, for flexible pipes; tinted plastic films for use on vehicle windows; bags [envelopes, pouches] of rubber, for packaging; connecting hose for vehicle radiators; non-conducting materials for retaining heat; insulating materials; padding materials of rubber or plastics; adhesive bands for sealing cigarette cartons for industrial or commercial use.

18 Backpacks; trunks (luggage); wallets; reusable shopping bags; business card cases; card cases (notecases); credit card cases (wallets); key cases (leatherware); umbrellas.

24 Cloth; upholstery fabrics; plastic material (substitute for fabrics); towels; bath towels; turban towels for drying hair; cloths for removing make-up; sleeping bags; sleeping bags for babies and children; bedsheets.

25 Caps being headwear; scarfs; shoes; coats; clothing; girdles; sports jerseys; trousers; sports shoes; hosiery.

27 Wall coverings of paper; decorative wall hangings, not of textile; carpets for vehicles; floor mats for vehicles; carpets for automobiles; floor coverings; non-slip mats; wallpaper.

28 Model cars; plush toys; smart toys; toy watches; toy cameras; body-building apparatus; running machines; controllers for game consoles; apparatus for games; joysticks for video games.

(540) **AITO**

Note: Opposition period for this trademark expires on **19.10.2024**

(210) 1615287;

(220) 25.03.1961

(731) Chongqing Amity Machinery Co., Ltd. 28-5#, No. 200 Zhongshan 2 Road, Yuzhong District Chongqing, China

(511) Int.Cl. 6, 7, 8, 9, 10, 11,21

(510):

06 Safes [strong boxes]; traps for wild animals; nails; bells for animals; steel wire; hooks [metal hardware]; reinforcing materials of metal for pipes; junctions of metal for pipes; elbows of metal for pipes; fittings of metal for furniture; fittings of metal for building; labels of metal; valves of metal, other than parts of machines; weather- or wind-vanes of metal; tool chests of metal, empty; padlocks of metal, other than electronic; pipes of metal; soldering wire of metal; rods of metal for welding; hinges of metal; vice claws of metal; pulleys of metal, other than for machines; monuments of metal; building materials of metal; angle irons of metal; scaffolding of metal; staircases of metal; screws of metal; non-electric door bells of metal; nozzles of metal; wall plugs of metal; ropes of metal; locks of metal, other than electric; steps [ladders] of metal; sleeves [metal hardware]; keys of metal; fences of metal; props of metal; identification bracelets of metal; collars of metal for fastening pipes; buildings, transportable, of metal; bands of metal for tying-up purposes; clips of metal for cables and pipes; anchors; alloys of common metal; buckles of common metal [hardware]; works of art of common metal; tree protectors of metal; iron ores; railway material of metal; unwrought or semi-wrought common metals; small hardware of metal.

07 Agricultural machines; lawnmowers [machines]; aerating pumps for aquaria; forage cutters; milking machines; electric hair clipping machines; woodworking machines; saws [machines]; paperboard making machines; machines for making diaper-pants of paper; printing machines; weaving looms; sizing machines; tea processing machines; electromechanical food preparation machines; brewing machines; tobacco processing machines; leather-working machines; stitching machines; bicycle assembling machines; brick making machines; engraving machines; machines for making electric batteries; cord making machines; enamel making machines; machines for making bulbs; packaging machines; machines for making coal briquettes; electric kitchen machines; washing machines [laundry]; centrifugal mills; glue applying machines; glass-working machines; fertilizers making machines; electromechanical machines for chemical industry; mine borers; cutters [machines]; oil-well pumps for the petroleum industry; mixing machines; disintegrators; cranes [lifting and hoisting apparatus]; pneumatic hammers; trimming machines; foundry machines; metalworking machines; steam engines; igniting devices for internal combustion engines; wind-powered installations for generating electricity; machines for making needles; machines for making zippers; stands for machines; cutting machines; machines for making wires and cables; tools [parts of machines]; machines and apparatus for polishing [electric]; drilling heads [parts of machines]; hand-held tools, other than hand-operated; power-operated angle grinders; machines for electronic industry; optics cold-processing machines; machines for separating gas; paint spraying machines; dynamos; motors, other than for land vehicles; pumps [machines]; valves [parts of machines]; compressed air machines; pneumatic cylinder (part of machines); propulsion mechanisms, other than for land vehicles; bearings [parts of machines]; belts for machines; electric welding machines; electric machines and apparatus for cleaning; high pressure washers; vacuum cleaners; filter presses; electric door rollers; electric shoe polishers; electroplating machines; electric door openers; electric scissors; hand-hold electrical drill; pneumatic nail guns; spray guns for paint; electric door

closers; electric window openers; electric window closers; steam mops; vacuum cleaner attachments for disseminating perfumes and disinfectants; cleaning appliances utilizing steam; electric machines and apparatus for carpet shampooing; brushes for vacuum cleaners; meat choppers [machines]; jacks [machines]; pneumatic hand tools, namely pneumatic grinding machines, pneumatic polishing machines, pneumatic sanders with abrasive belts, pneumatic spanners, pneumatic screwdriver, pneumatic riveters; butter machines; bread cutting machines; kneading machines; flour mill machines; electric juice extractors; electromechanical beverage preparation machines; dry-cleaning machines; road rollers; industrial robots; electric whisks for household purposes; mills for household purposes, other than hand-operated; coffee grinders, other than hand-operated.

08 Table cutlery [knives, forks and spoons]; perforating tools [hand tools]; graving tools [hand tools]; instruments and tools for skinning animals; hand implements for hair curling; riveters [hand tools]; abrading instruments [hand instruments]; hand-operated agricultural implements; sabres; hand-operated hand tools; hand-operated guns for the extrusion of mastics; hand-operated lifting jacks; handles for hand-operated hand tools; beard clippers; secateurs; manicure sets; harpoons; hand-operated garden tools; flat irons; trowels for mason; bits [parts of hand tools].

09 Semi-conductors; alarms; lightning rods; surveying apparatus and instruments; square rulers for measuring; measuring apparatus; pressure measuring apparatus; rulers [measuring instruments]; sensor; navigational instruments; electric measuring devices; electric plugs; electric sockets; electric batteries; chargers for electric batteries; electronic video surveillance apparatus; electric contacts; electrolyzers; electric switches; electric door bells; electric couplings; condensers [capacitors]; television apparatus; electric locks; materials for electricity mains [wires, cables]; covers for electric outlets; electric theft prevention installations; electronic notice boards; electronic chip cards; electronic slide calipers; animated cartoons; circuit breakers; interphones; protective masks; clothing for protection against accidents, irradiation and fire; shoes for protection against accidents, irradiation and fire; gloves for protection against accidents; lasers, not for medical purposes; thermometers, not for medical purposes; photocopiers [photographic, electrostatic, thermic]; protection devices for personal use against accidents; knee-pads for workers; safety boots for industrial use; radiological apparatus for industrial purposes; industrial endoscope cameras; optical apparatus and instruments; optical fibers [light conducting filaments]; tachographs; weighing apparatus and instruments; chemistry apparatus and instruments; counters; computer programs [downloadable software]; computer network switches; computer network bridges; tape measures; video phones; downloadable software applications for mobile phones; air analysis apparatus; control panels [electricity]; electronic access control systems for interlocking doors; measures; fire extinguishing apparatus; gas testing instruments; micrometer gauges; ear plugs for divers; heat regulating apparatus; face identification apparatus; biometric fingerprint door locks; video monitor; video screens; levels [instruments for determining the horizontal]; bathroom scales; voting machines; internet router; radio receivers and transmitters; radios; radio signal tuners; wireless routers; smoke

detectors; eyeglasses; counterfeit coin detectors; cabinets for loudspeakers; remote control apparatus; mobile power supplies, namely rechargeable batteries; apparatus to check franking; slide calipers; printers for use with computers; speed checking apparatus for vehicles; rearview cameras for vehicles; cameras [photography]; smart watches (data processing); smart eyeglasses (data processing); ticket dispensers.

10 Ear plugs for soundproofing, other than for medical use; feeding bottles; orthopaedic articles; gloves for medical purposes; surgical apparatus and instruments; dental apparatus and instruments; artificial limbs; condoms; suture materials; apparatus for use in medical analysis; physiotherapy apparatus; ear plugs [ear protection devices]; massage apparatus; thermometers for medical purposes; glucometers; body fat monitors; cholesterol meters; hearing aids; soporific pillows for insomnia; arterial blood pressure measuring apparatus.

11 Lamps; pocket warmers; kitchen ranges [ovens]; extractor hoods for kitchens; lighters; light bulbs; electric cooking utensils; electric lamps; electric appliances for making yogurt; electric soya milk making machines; electric heating apparatus; electric autoclaves for cooking; empty coffee capsules for electric coffee machines; electric coffee percolators; electric coffee machines; electric radiators; electrically heated clothing; electric kettles; electric deep fryers; electric food steamers; fans [air-conditioning]; pipes [parts of sanitary installations]; humidifiers; electric rice cookers for household purposes; electric water purifier for household purposes; humidifiers for household purposes; domestic cooking ovens; water intake apparatus; polymerisation installations; bread toasters; griddles [cooking appliances]; air driers; air purifier for household purposes; germicidal lamps for purifying air; air purifying apparatus and machines; air-conditioning installations; air sterilisers; air reheaters; air fryers; refrigerating cabinets; refrigerating appliances and installations; cooling appliances and installations; heating and cooling apparatus for dispensing hot and cold beverages; taps; anti-splash tap nozzles; gas burners; electric heaters for feeding bottles; fountains; cooking apparatus and installations; gas condensers, other than parts of machines; gas burners; heat guns; fluorescent lighting tube; electric torches; water filtering apparatus; water purifying apparatus and machines; water purification installations; searchlights; curling lamps; hair driers; microwave ovens [cooking apparatus]; sanitary apparatus and installations; fog machines; disinfectant apparatus; cocks for pipes and pipelines; lava rocks for use in barbecue grills; oil lamps; bath installations; lights for vehicles; lighting apparatus and installations; fabric steamers; ice machines and apparatus; automatic watering installations.

21 Containers for household or kitchen use; insect traps; kitchen utensils; works of art of porcelain, ceramic, earthenware, terra-cotta or glass; electric toothbrushes; non-electric cooking utensils; toilet utensils; cosmetic utensils; ceramics for household purposes; gloves for household purposes; glass bowls; dustbins; watering cans; steel wool for cleaning; glassware for household purposes, namely cups, plates, kettles, and jars; porcelain ware for household purposes, namely basins, bowls, plates, kettles, tableware, jars, jugs, and pots; enamel ware and plastic ware for household purposes, namely basins, bowls, plates, kettles, and cups; sprinklers; thermally insulated containers for food; indoor aquaria; cleaning

instruments, hand-operated; brushes; mops; mop wringer buckets; glass, unworked or semi-worked, except building glass; drying racks for laundry; toothbrushes; drinking troughs; drinking vessels; gardening gloves.

(540) **DYLLU**

Note: Opposition period for this trademark expires on **19.10.2024**

(210) 1756098;

(220) 28.04.2023

(731) Xiamen Eopaia Imp & Exp Trading Corp. Unit A, Floor 12, Zhongxin Huiyang Building, No 59 Hubin North Road, Siming District, Xiamen City, Fujian Province, China

(511) Int.Cl. 25

(510) Clothing; sports jerseys; sports shoes; jumping shoes; boots for sports; studs for football boots; football shoes; running shoes (with metal spikes); footwear; headwear.



(540)

Note: Opposition period for this trademark expires on **19.10.2024**

(210) 1755597;

(220) 01.09.2023

(731) Joy Kie Corporation Limited, 16F, Guangxin Building, No. 36, 38, 46, 50, 56, 58 and 66, Xintang Road, Shangcheng District, Hangzhou 310000 Zhejiang, China

(511) Int.Cl. 12, 28

(510):

12 Saddles for bicycles, cycles or motorcycles; bicycle seats; bicycles; electric bicycles; bicycle frames; baskets adapted for bicycles; saddle covers for bicycles or motorcycles; mini motor cars; strollers; safety seats for children, for vehicles.

28 Games; tricycles for infants [toys]; chess games; balls for games; body-building apparatus; archery implements; machines for physical exercises; swimming pools [play articles]; knee guards [sports articles]; in-line roller skates.

久祺

(540)

Note: Opposition period for this trademark expires on **12.10.2024**

(210) 1755617;

(220) 02.08.2023

(731) Qingdao Sicuro Tyre Co.,Ltd. 2022-2524 (A), 1st Floor, East Office Building, No. 45 Beijing Road, Qianwan Port Bonded Port Area of Qingdao Area, Pilot Free Trade Zone(Shandong) 266555 Qingdao City, China

(511) Int.Cl. 12

(510) Automobile tyres; bicycle tyres; inner tubes for pneumatic tyres; tyres for vehicle wheels; casings for pneumatic tyres; solid tyres for vehicle wheels; wheels for automobiles; inner tubes for bicycle tyres; upholstery for vehicles; pneumatic tyres.

Sicuro

(540)

Note: Opposition period for this trademark expires on **12.10.2024**

(210) 1755621;

(220) 26.07.2023

(731) Shandong Heshuo New Energy Technology Co., Ltd.(Opposite the City Law Enforcement Bureau), North of 500 meters west of the intersection of Qilianshan Road and Zaocao Road, Xingren Street Zaozhuang High-tech Zon, China

(511) Int.Cl. 9

(510) Distribution boxes [electricity]; battery boxes; battery chargers; photovoltaic devices and equipment for solar power generation; charging stations for electric vehicles; mobile power supply [rechargeable batteries]; charging posts for electric vehicles; lithium-ion battery cases; accumulator boxes; solar panels for the production of electricity.



(540)

Note: Opposition period for this trademark expires on **12.10.2024**

STATUTORY NOTICES UNDER THE TRADE MARKS ACT (CAP. 401)

TRADE MARKS REGISTERED. (FG).

(111) 303/2017; (151) 27.02.2017.

(511) Int. Cl.9.

(540) **SEBANG Logo**

(732) Sebang Global Battery Co., Ltd of 433, Seolleung-ro, Gangnam-gu, Seoul (135-919), Republic of Korea.

(111) 926/2017; (151) 20.06.2017.

(511) Int. Cl.30.

(540) **SUBWAY (and logo)**

(732) SUBWAY IP Inc., of 325 Sub Way, Milford, CT 06461, United States of America

(111) 1778/2017; (151) 01.11.2017.

(511) Int. Cl.18.

(540) **ULENDO**

(732) Eascor Investment Limited of 179A Kuomboka, Makeni, Lusaka, Zambia.

(111) 1832/2017; (151) 08.11.2017.

(511) Int. Cl.33.

(540) **DEVICE MARK (and logo)**

(732) Oasis Distilleries Limited of H-1-2, B-2 Metro Towers, Scheme No. 54, Vijay Nagar, Indore - 452010 Madhya Pradesh, India.

(111) 209/2018; (151) 26.02.2018.

(511) Int. Cl.16.

(540) **PREMUNI & logo**

(732) Premuni Investment Limited of P.O. Box 38303, Plot No. 5978, Lusaka, Zambia.

(111) 1601/2019; (151) 07.11.2019.

(511) Int. Cl.30.

(540) **RHINO (and logo)**

(732) Ascensio Investments Limited of Plot No. 39758/M, Solwezi Chingola Road, Tetamukanwa Village, P.O. Box 110463 , Solwezi, Zambia.

(111) 1030/2020; (151) 04.06.2020.

(511) Int. Cl.32.

(540) **SHAKE 'N SIP FRUITY MILK BANANA FLAVOURED AND LOGO**

(732) Dairy Gold Limited of Plot No. 29381, Nampundwe Road, Light Industrial Area, P.O. Box 30824, Lusaka, Zambia.

(111) 1849/2020; (151) 12.08.2020.

(511) Int. Cl.29.

(540) **Cbeebies**

(732) Elite Industries Limited of Stand No. 1951/5 Off Mumbwa Road, Lusaka, Zambia.

(111) 2146/2020; (151) 23.09.2020.

(511) Int. Cl.32.

(540) **BIB'S COLA (and logo)**

(732) Bibagry Limited of Lot 6028, Kamfinsa Road, Kamfinsa, Kitwe, Zambia.

(111) 100/2021; (151) 22.01.2021.

(511) Int. Cl.12.

(540) **BENDIX (and logo)**

(732) Garrett Transportation I Inc. of 2525 W. 190th Street, Torrance, California 90504, United States of America.

(111) 712/2021; (151) 12.05.2021.

(511) Int. Cl.30.

(540) **GOOD NATURED (and logo)**

(732) Elite Industries Limited of Stand No. 1951/5, Off Mumbwa Road, Industrial Area, Lusaka, Zambia.

(111) 715/2021; (151) 12.05.2021.

(511) Int. Cl.30.

(540) **SWEET DIPS (and logo)**

(732) Elite Industries Limited of Stand No. 1951/5, Off Mumbwa Road, Industrial Area, Lusaka, Zambia.

(111) 728/2021; (151) 12.05.2021.

(511) Int. Cl.32.

(540) GO plus (and logo)

(732) Elite Industries Limited of Stand No. 1951/5, Off Mumbwa Road, Industrial Area, Lusaka, Zambia.

(111) 729/2021; (151) 12.05.2021.

(511) Int. Cl.32.

(540) **Milk UP?? (and logo)**

(732) Elite Industries Limited of Stand No. 1951/5, Off Mumbwa Road, Industrial Area, Lusaka, Zambia.

(111) 731/2021; (151) 12.05.2021.

(511) Int. Cl.32.

(540) **B-More (and logo)**

(732) Elite Industries Limited of Stand No. 1951/5, Off Mumbwa Road, Industrial Area, Lusaka, Zambia.

(111) 732/2021; (151) 12.05.2021.

(511) Int. Cl.32.

(540) **Contact-CSD (and logo)**

(732) Elite Industries Limited of Stand No. 1951/5, Off Mumbwa Road, Industrial Area, Lusaka, Zambia.

(111) 733/2021; (151) 12.05.2021.

(511) Int. Cl.32.

(540) **FLORINA (and logo)**

(732) Elite Industries Limited of Stand No. 1951/5, Off Mumbwa Road, Industrial Area, Lusaka, Zambia.

(111) 734/2021; (151) 12.05.2021.

(511) Int. Cl.32.

(540) **STRIKE (and logo)**

(732) Elite Industries Limited of Stand No. 1951/5, Off Mumbwa Road, Industrial Area, Lusaka, Zambia.

(111) 735/2021; (151) 12.05.2021.

(511) Int. Cl.32.

(540) **CLUB ZED (and logo)**

(732) Elite Industries Limited of Stand No. 1951/5, Off Mumbwa Road, Industrial Area, Lusaka, Zambia.

(111) 736/2021; (151) 12.05.2021.

(511) Int. Cl.33.

(540) **FLORINA (and logo)**

(732) Elite Industries Limited of Stand No. 1951/5, Off Mumbwa Road, Industrial Area, Lusaka, Zambia.

(111) 738/2021; (151) 12.05.2021.

(511) Int. Cl.33.

(540) **CLUB ZED (and logo)**

(732) Elite Industries Limited of Stand No. 1951/5, Off Mumbwa Road, Industrial Area, Lusaka, Zambia.

(111) 739/2021; (151) 12.05.2021.

(511) Int. Cl.5.

(540) **ANCHOR (and logo)**

(732) Elite Industries Limited of Stand No. 1951/5, Off Mumbwa Road, Industrial Area, Lusaka, Zambia.

(111) 827/2021; (151) 28.05.2021.

(511) Int. Cl.3.

(540) **INGRAM'S 2020 (and logo)**

(732) Tiger Food Brands Intellectual Property Holding Company (Proprietary) Limited of 3010 William Nicol Drive, Bryanston, Johannesburg, Gauteng, South Africa.

(111) 986/2021; (151) 09.06.2021.

(511) Int. Cl.32.

(540) **PAPA**

(732) Elite Industries Limited of Stand No. 1951/5 Off Mumbwa, Lusaka, Zambia.

(111) 987/2021; (151) 09.06.2021.

(511) Int. Cl.32.

(540) **PRESIDENTIAL**

(732) Elite Industries Limited of Stand No. 1951/5 Off Mumbwa, Lusaka, Zambia.

(111) 1010/2021; (151) 15.06.2021.

(511) Int. Cl.3.

(540) **Sunfresh (and logo)**

(732) Wozani Resources Limited of Stand No. 2374, Cco House, Kelvin Siwale Road, Lusaka, Zambia.

(111) 1171/2021; (151) 12.07.2021.

(511) Int. Cl.16.

(540) **MIKA MEATS Logo**

(732) Mika Meats Limited of 32 Msuzi Road Woodlands, Lusaka , Zambia.

(111) 1172/2021; (151) 12.07.2021.

(511) Int. Cl.16.

(540) **MEATING YOUR DAILY NEEDS**

(732) Mika Meats Limited of 32 Msuzi Road Woodlands, Lusaka, Zambia.

(111) 1173/2021; (151) 12.07.2021.

(511) Int. Cl.25.

(540) **MIKA MEATS Logo**

(732) Mika Meats Limited of 32 Msuzi Road Woodlands, Lusaka, Zambia.

(111) 1174/2021; (151) 12.07.2021.

(511) Int. Cl.29.

(540) **MIKA MEATS Logo**

(732) Mika Meats Limited of 32 Msuzi Road Woodlands, Lusaka, Zambia.

(111) 1216/2021; (151) 22.07.2021.

(511) Int. Cl.32.

(540) **ZAMCOLA (and logo)**

(732) Elite Industries Limited of Stand No. 1951/5 Off Mumbwa Road, Lusaka, Zambia.

(111) 1217/2021; (151) 22.07.2021.

(511) Int. Cl.5.

(540) **MY LADY (and logo)**

(732) Elite Industries Limited of Stand No. 1951/5 Off Mumbwa Road, Lusaka,, Zambia.

(111) 1218/2021; (151) 22.07.2021.

(511) Int. Cl.5.

(540) **GIRL TALK (and logo)**

(732) Elite Industries Limited of Stand No. 1951/5 Off Mumbwa Road, Lusaka, Zambia.

(111) 1219/2021; (151) 22.07.2021.

(511) Int. Cl.5.

(540) **HOME TIME (and logo)**

(732) Elite Industries Limited of Stand No. 1951/5 Off Mumbwa Road, Lusaka, Zambia.

(111) 1251/2021; (151) 26.07.2021.

(511) Int. Cl.9.

(540) **STARLINK**

(732) Space Exploration Technologies Corp. of 1 Rocket Road, Hawthorne, California 90250, United States of America.

(111) 1306/2021; (151) 09.08.2021.

(511) Int. Cl.32.

(540) **HUSTLER ENERGY DRINK (and logo)**

(732) Elite Industries Limited of Stand No. 1951/5, Off Mumbwa Road, Industrial Area , Lusaka, Zambia.

(111) 1467/2021; (151) 02.09.2021.

(511) Int. Cl.16.

(540) **BELLASCREATIVITY (hair and beauty on another level) (and logo)**

(732) Bella's Creativity Limited of No. 108 Geddes Street Nkana East, Kitwe, Zambia.

(111) 219/2022; (151) 15.02.2022.

(511) Int. Cl.5.

(540) **VALUS AP Logo**

(732) Glenmark Pharmaceuticals Limited of B/2 Mahalaxmi Chamber 22 Bhulabhai Desai Road, Mumbai 400026, India.

(111) 281/2022; (151) 23.02.2022.

(310) 018606441 (320) 23.11.2021 (330) DK

(511) Int. Cl.28.

(540) **DUPLO (V49 V DEVICE IN COLOUR) (and logo)**

(732) LEGO Juris A/S of 7190 Billund, Denmark.

(111) 564/2022; (151) 01.04.2022.

(511) Int. Cl.9.

(540) **PRECISION POWA**

(732) Motus Group Limited of 1 Van Buuren Road, Cnr Geldenhuis & van Dort Streets, Bedfordview, 2008, South Africa.

(111) 780/2022; (151) 16.05.2022.

(511) Int. Cl.34.

(540) **ESSE CHANGE PLUS (and logo)**

(732) KT&G CORPORATION of 71, Beotkkot-gil, Daedeok-gu Daejeon, Republic of Korea.

(111) 781/2022; (151) 16.05.2022.

(511) Int. Cl.34.

(540) **ESSE CHANGE (and logo)**

(732) KT&G CORPORATION of 71, Beotkkot-gil, Daedeok-gu Daejeon, Republic of Korea.

(111) 866/2022; (151) 07.06.2022.

(511) Int. Cl.9.

(540) **BYTELLO stylized (and logo)**

(732) Guangzhou Shiyuan Electronic Technology Company Limited of No. 6, 4th Yunpu Road, Huangpu District, Guangzhou, Peoples Republic of China.

(111) 867/2022; (151) 07.06.2022.

(511) Int. Cl.9.

(540) **SEEWOW stylized (and logo)**

(732) Guangzhou Shiyuan Electronic Technology Company Limited of No. 6, 4th Yunpu Road, Huangpu District, Guangzhou, Peoples Republic of China.

(111) 904/2022; (151) 14.06.2022.

(511) Int. Cl.32.

(540) **HEINEKEN SILVER**

(732) Heineken Brouwerijen B.V. (a Netherlands private limited company) of Tweede Weteringplantsoen 21, 1017 ZD, Amsterdam, Netherlands.

(111) 905/2022; (151) 14.06.2022.

(511) Int. Cl.33.

(540) **HEINEKEN SILVER**

(732) Heineken Brouwerijen B.V. (a Netherlands private limited company) of Tweede Weteringplantsoen 21, 1017 ZD, Amsterdam, Netherlands.

(111) 1141/2022; (151) 25.07.2022.

(511) Int. Cl.5.

(540) **GLIMULIN**

(732) Glenmark Pharmaceuticals Limited of B/2, Mahalaxmi Chambers, 22, Bhulabhai Desai Road, Mumbai-400 026, India.

(111) 1153/2022; (151) 25.07.2022.

(511) Int. Cl.24.

(540) **VEVA WAX & Logo**

(732) Polytex Investments Limited of Number 348, Plot 34355, The Point Mall, Off Bombay Road, Kamwala, Lusaka, Zambia.

(111) 1238/2022; (151) 11.08.2022.

(511) Int. Cl.34.

(540) **SAFARI Series of 2 (Blue and B & W Label)**

(732) British American Tobacco (Brands) Limited of Globe House, 4 Temple Place, London WC2R 2PG, United Kingdom.

(111) 1279/2022; (151) 24.08.2022.

(511) Int. Cl.9.

(540) **ITEL Logo**

(732) ITEL Technology Limited of Flat N, 16/F., Block B, Universal Industrial Centre,19-25, Shan Mei Street, Fotan, New Territories, Hong-Kong.

(111) 1280/2022; (151) 24.08.2022.

(511) Int. Cl.11.

(540) **ITEL Logo**

(732) ITEL Technology Limited of Flat N, 16/F., Block B, Universal Industrial Centre,19-25, Shan Mei Street, Fotan, New Territories, Hong-Kong.

(111) 1348/2022; (151) 08.09.2022.

(511) Int. Cl.9.

(540) **MAHOLLA**

(732) MAHOLLA B.V. of Herengracht 449a, 1017 BR Amsterdam, Netherlands.

(111) 1359/2022; (151) 13.09.2022.

(511) Int. Cl.16.

(540) **KWACHA TRIBE (and logo)**

(732) Talanta Online Limited of 336 Poinsettia avenue, Avondale, Lusaka , Zambia.

(111) 1374/2022; (151) 14.09.2022.

(511) Int. Cl.12.

(540) **ENCORE**

(732) Brands Infinite (Pty) Ltd of 37 Visagie Street, Cnr Potgieter Street, Pretoria, 0002, South Africa.

(111) 1417/2022; (151) 27.09.2022.

(511) Int. Cl.29.

(540) **CHOCATELLA**

(732) Ebees Investments Limited of Plot No. 199, P.O Box 30508, Lusaka, Zambia.

(111) 1638/2022; (151) 28.10.2022.

(511) Int. Cl.29.

(540) **TEMBO (and logo)**

(732) Ascensio Investment Limited of Plot No. 39758/M, Chingola Road, Kapijimpanga Area, Solwezi, Zambia.

(111) 1646/2022; (151) 01.11.2022.

(511) Int. Cl.29.

(540) **EBEES NUTZ BUZZ**

(732) Ebees Investments Limited of Plot No. 199 Chandwe Musonda Road, P.O Box 30508, Lusaka, Zambia.

(111) 1700/2022; (151) 14.11.2022.

(511) Int. Cl.5.

(540) **VINTOR (and logo)**

(732) Emcure Pharmaceuticals Limited of Emcure House, T-184, M.I.D.C. Bhosari - 411 026, Pune , Maharashtra, India.

(111) 1701/2022; (151) 14.11.2022.

(511) Int. Cl.5.

(540) **NUSAR**

(732) Emcure Pharmaceuticals Limited of Emcure House, T-184, M.I.D.C. Bhosari - 411 026, Pune , Maharashtra, India.

(111) 1746/2022; (151) 22.11.2022.

(511) Int. Cl.5.

(540) **CONFIDENCE (and logo)**

(732) New Gen Investment Limited of Plot 136, Freedom Way, Town Centre, FW 266, Lusaka, Zambia.

(111) 1747/2022; (151) 22.11.2022.

(511) Int. Cl.5.

(540) **ADFIT (and logo)**

(732) New Gen Investment Limited of Plot 136, Freedom Way, Town Centre, FW 266,
Lusaka, Zambia.

(111) 1750/2022; (151) 22.11.2022.

(511) Int. Cl.5.

(540) **PAUSE (and logo)**

(732) Emcure Pharmaceuticals Limited of Emcure House T-184, M.I.D.C. Bhosari - 411 026,
Pune Maharashtra, India.

(111) 1932/2022; (151) 29.12.2022.

(511) Int. Cl.9.

(540) **MARS**

(732) Bo Xu of Farm 50A, Makeni, Lusaka, Lusaka, Zambia.

(111) 1933/2022; (151) 29.12.2022.

(511) Int. Cl.14.

(540) **MARS**

(732) Bo Xu of Farm 50A, Makeni, Lusaka, Zambia.

(111) 123/2023; (151) 01.02.2023.

(511) Int. Cl.1.

(540) **LAHAR**

(732) UPL Mauritius Limited of 6th Floor, Suite 157B, Harbor Front Building, President
John Kennedy Street, Port Louis, Mauritius.

(111) 124/2023; (151) 01.02.2023.

(511) Int. Cl.5.

(540) **LAHAR**

(732) UPL Mauritius Limited of 6th Floor, Suite 157B, Harbor Front Building, President
John Kennedy Street, Port Louis, Mauritius.

(111) 125/2023; (151) 01.02.2023.

(511) Int. Cl.1.

(540) **SPRINT**

(732) UPL Mauritius Limited of 6th Floor, Suite 157B, Harbor Front Building, President
John Kennedy Street, Port Louis, Mauritius.

(111) 126/2023; (151) 01.02.2023.

(511) Int. Cl.5.

(540) **SPRINT**

(732) UPL Mauritius Limited of 6th Floor, Suite 157B, Harbor Front Building, President
John Kennedy Street, Port Louis, Mauritius.

(111) 128/2023; (151) 01.02.2023.

(511) Int. Cl.5.

(540) **QUAKE**

(732) UPL Mauritius Limited of 6th Floor, Suite 157B, Harbor Front Building, President
John Kennedy Street, Port Louis, Mauritius.

(111) 130/2023; (151) 01.02.2023.

(511) Int. Cl.5.

(540) **GAUNTLETT**

(732) UPL Mauritius Limited of 6th Floor, Suite 157B, Harbor Front Building, President
John Kennedy Street, Port Louis, Mauritius.

(111) 420/2023; (151) 29.03.2023.

(511) Int. Cl.9.

(540) **AMAZON & SMILE (and logo)**

(732) Amazon Technologies, Inc. of 410 Terry Avenue North Seattle, Washington 98109,
United States of America.

(111) 421/2023; (151) 29.03.2023.

(511) Int. Cl.10.

(540) **AMAZON & SMILE (and logo)**

(732) Amazon Technologies, Inc. of 410 Terry Avenue North Seattle, Washington 98109,
United States of America.

(111) 422/2023; (151) 29.03.2023.

(511) Int. Cl.11.

(540) **AMAZON & SMILE (and logo)**

(732) Amazon Technologies, Inc. of 410 Terry Avenue North Seattle, Washington 98109, United States of America.

(111) 423/2023; (151) 29.03.2023.

(511) Int. Cl.14.

(540) **AMAZON & SMILE (and logo)**

(732) Amazon Technologies, Inc. of 410 Terry Avenue North Seattle, Washington 98109, United States of America.

(111) 430/2023; (151) 29.03.2023.

(511) Int. Cl.9.

(540) **AMAZON**

(732) Amazon Technologies, Inc. of 410 Terry Avenue North Seattle, Washington 98109, United States of America.

(111) 431/2023; (151) 29.03.2023.

(511) Int. Cl.10.

(540) **AMAZON**

(732) Amazon Technologies, Inc. of 410 Terry Avenue North Seattle, Washington 98109, United States of America.

(111) 432/2023; (151) 29.03.2023.

(511) Int. Cl.11.

(540) **AMAZON**

(732) Amazon Technologies, Inc. of 410 Terry Avenue North Seattle, Washington 98109, United States of America.

(111) 433/2023; (151) 29.03.2023.

(511) Int. Cl.14.

(540) **AMAZON**

(732) Amazon Technologies, Inc. of 410 Terry Avenue North Seattle, Washington 98109, United States of America.

(111) 434/2023; (151) 29.03.2023.

(511) Int. Cl.16.

(540) **AMAZON (and logo)**

(732) Amazon Technologies, Inc. of 410 Terry Avenue North Seattle, Washington 98109, United States of America.

(111) 448/2023; (151) 31.03.2023.

(511) Int. Cl.9.

(540) **WEYON stylized (and logo)**

(732) Fujian Xiaofu Technology Co., of Room 1835, Area A,15th Floor, Comprehensive Building Fuzhou Free Trade Zone, Fujian Province, Peoples Republic of China.

(111) 449/2023; (151) 31.03.2023.

(511) Int. Cl.11.

(540) **KELVINATOR**

(732) Electrolux home products, INC of 10200 David Taylor Drive, Charlotte, North Carolina, 28262, United States of America.

(111) 487/2023; (151) 05.04.2023.

(511) Int. Cl.16.

(540) **DUMA (and Logo)**

(732) Duma Milling Limited of Plot No. 7A/110A Musonda Ngosa Road, Villa Elizabetha, Zambia.

(111) 556/2023; (151) 19.04.2023.

(511) Int. Cl.16.

(540) **BIDVEST BANK (and logo)**

(732) Bidvest Industrial Holdings (Pty) Ltd of 2nd Floor, Bidvest House, 18 Crescent Drive, Melrose, Arch, 2196, South Africa.

(111) 575/2023; (151) 25.04.2023.

(511) Int. Cl.26.

(540) **ADMIRE (and logo)**

(732) Csgson Investment Limited of Plot No. 22114, Off Mumbwa Road, Lusaka, Zambia.

(111) 576/2023; (151) 25.04.2023.

(511) Int. Cl.26.

(540) **ZHENGHUA (and logo)**

(732) Csgson Investment Limited of Plot 22114, Off Mumbwa Road, Lusaka, Zambia.

(111) 859/2023; (151) 20.06.2023.

(511) Int. Cl.6.

(540) **FABRINOX & DEVICE**

(732) Fabrinnox (Pty) Limited of Corner of Driebergen & Drommedaris Roads, Paarl 7645 , South Africa.

(111) 990/2023; (151) 30.06.2023.

(511) Int. Cl.9.

(540) **NEW ORLEANS PELICANS with Pelican and Ball Design (Global Logo 2023- Present) device (and logo)**

(732) NBA Properties, Inc. of Olympic Tower, 645 Fifth Avenue, New York, NY 10022, United states

(111) 991/2023; (151) 30.06.2023.

(511) Int. Cl.25.

(540) **NEW ORLEANS PELICANS and Logo**

(732) NBA Properties, Inc. of Olympic Tower, 645 Fifth Avenue, New York, NY 10022, United States of America.

(111) 992/2023; (151) 30.06.2023.

(511) Int. Cl.5.

(540) **ENTOP**

(732) ASPEN Pharmacare Australia Pty Ltd of 34-36 Chandos Street, St Leonards, NSW 2065, Australia.

(111) 1069/2023; (151) 14.07.2023.

(511) Int. Cl.3.

(540) **STAR MEN**

(732) Andrew Milau Trading Limited of Shop No.210, COMESA, Lusaka, Zambia.

(111) 1070/2023; (151) 14.07.2023.

(511) Int. Cl.3.

(540) **BOY FRIEND**

(732) Andrew Milau Trading Limited of Shop No.210, COMESA, Lusaka , Zambia.

(111) 1071/2023; (151) 14.07.2023.

(511) Int. Cl.3.

(540) **LIGHT-DENT**

(732) Andrew Milau Trading Limited of Shop No.210, COMESA, Lusaka , Zambia.

(111) 1164/2023; (151) 20.07.2023.

(511) Int. Cl.3.

(540) **SMART PICK (and logo)**

(732) Sokowatch Inc of 1209, Orange Street, Wilmington, New Castle County, Delaware, United States Of America.

(111) 1165/2023; (151) 20.07.2023.

(511) Int. Cl.30.

(540) **SMART PICK (and logo)**

(732) Sokowatch Inc of 1209, Orange Street, Wilmington, New Castle County, Delaware, United States of America.

(111) 1224/2023; (151) 28.07.2023.

(511) Int. Cl.4.

(540) **PETREPOWER**

(732) Petredec Holdings Pte. Ltd of 1 Wallich Street, #32-01 Guoco Tower, Singapore 078881, Singapore.

(111) 1225/2023; (151) 28.07.2023.

(511) Int. Cl.9.

(540) **PETREPOWER**

(732) Petredec Holdings Pte. Ltd of 1 Wallich Street, #32-01 Guoco Tower, Singapore 078881, Singapore.

(111) 1226/2023; (151) 28.07.2023.

(511) Int. Cl.16.

(540) **PETREPOWER**

(732) Petredec Holdings Pte. Ltd of 1 Wallich Street, #32-01 Guoco Tower, Singapore 078881, Singapore.

(111) 1262/2023; (151) 02.08.2023.

(511) Int. Cl.7.

(540) **PFERD (and logo)**

(732) August Ruggeberg Gmbh & Co. KG of Hauptstrabe 13, 51709 Marienheide, Germany.

(111) 1263/2023; (151) 02.08.2023.

(511) Int. Cl.8.

(540) **PFERD (and logo)**

(732) August Ruggeberg Gmbh & Co. KG of Hauptstrabe 13, 51709 Marienheide, Germany.

(111) 1298/2023; (151) 10.08.2023.

(511) Int. Cl.16.

(540) **Play Zone (and logo)**

(732) Play Zone Limited of Plot A1 Villawanga Lusaka, Zambia.

(111) 1316/2023; (151) 15.08.2023.

(511) Int. Cl.3.

(540) **EPIGLOW (and logo)**

(732) Amina Limited of P.O. BOX 3175, Road Town, Tortola, British Virgin Island, Virgin Islands.

(111) 1397/2023; (151) 24.08.2023.

(511) Int. Cl.14.

(540) **TIME SQUARE**

(732) Bo Xu of Farm 50A, Makeni, Lusaka, Zambia.

(111) 1429/2023; (151) 29.08.2023.

(511) Int. Cl.16.

(540) **Kwetu Asili (and logo)**

(732) Sokowatch Inc of 1209 Orange Street, Wilmington, New Castle County, Delaware United States of America

(111) 1456/2023; (151) 30.08.2023.

(511) Int. Cl.32.

(540) **ULTRA POWER & Logo**

(732) Nice Business Ventures Limited of 20514, Chianina, Chinika Industrial Area, Lusaka , Zambia.

(111) 1464/2023; (151) 31.08.2023.

(511) Int. Cl.34.

(540) **KALULU**

(732) Life Sixty Three Investment of Plot No. 9575, Off Katanga Road, Light Industrial Area, Lusaka, Zambia.

(111) 1504/2023; (151) 06.09.2023.

(511) Int. Cl.31.

(540) **Afr Strong (and logo)**

(732) Zamgreen Agriculture Ltd, Lusaka of Plot # 3267 off Mungwi Road, Lusaka, Zambia.

(111) 1505/2023; (151) 07.09.2023.

(511) Int. Cl.31.

(540) **Afr Fresh (and logo)**

(732) Zamgreen Agriculture Ltd, Lusaka of Plot # 3267 off Mungwi Road, Lusaka, Zambia.

(111) 1506/2023; (151) 07.09.2023.

(511) Int. Cl.30.

(540) **Kwetu Asili (and logo)**

(732) Sokowatch Inc of 1209 Orange Street, Wilmington, New Castle County, Delaware United States of America.

(111) 1511/2023; (151) 08.09.2023.

(511) Int. Cl.4.

(540) **LAKE ENERGIES LOGO**

(732) Lake Petroleum Limited of Plot No. 10958, Magoye, Kalundu, Lusaka, Zambia.

(111) 1545/2023; (151) 12.09.2023.

(511) Int. Cl.1.

(540) **GROW-CAL**

(732) Sineria Holland B.V of Randwycksingel 20-A015 6229 Ee Maastricht, Netherlands.

(111) 1546/2023; (151) 12.09.2023.

(511) Int. Cl.1.

(540) **SUPER BORON EXTRA Logo**

(732) Sineria Holland B.V of Randwycksingel 20-A015 6229 Ee Maastricht, Netherlands.

(111) 1573/2023; (151) 15.09.2023.

(511) Int. Cl.28.

(540) **BETPAWA (and logo)**

(732) Nanovas Limited of F20, 1st Floor, Eden Plaza, Eden Island, Seychelles.

(111) 1574/2023; (151) 15.09.2023.

(511) Int. Cl.28.

(540) **BET SMALL, WIN BIG (and logo)**

(732) Nanovas Limited of F20, 1st Floor, Eden Plaza, Eden Island, Seychelles.

(111) 1575/2023; (151) 15.09.2023.

(511) Int. Cl.25.

(540) **PAWA**

(732) Nanovas Limited of F20, 1st Floor, Eden Plaza, Eden Island, Seychelles.

(111) 1576/2023; (151) 15.09.2023.

(511) Int. Cl.16.

(540) **PAWA**

(732) Nanovas Limited of F20, 1st Floor, Eden Plaza, Eden Island, Eden Island, Seychelles.

(111) 1577/2023; (151) 15.09.2023.

(511) Int. Cl.28.

(540) **PAWA**

(732) Nanovas Limited of F20, 1st Floor, Eden Plaza, Eden Island, Seychelles.

(111) 1656/2023; (151) 27.09.2023.

(511) Int. Cl.16.

(540) **BLINK and Logo**

(732) Blink Marketing Solutions Limited of Plot No. 1394, Aln, House, Mushemi Road, Lusaka, Zambia.

(111) 1657/2023; (151) 27.09.2023.

(511) Int. Cl.16.

(540) **BLINK and Logo**

(732) Blink Marketing Solutions Limited of Plot No. 1394, Aln, House, Mushemi Road, Lusaka, Zambia.

(111) 1673/2023; (151) 29.09.2023.

(511) Int. Cl.11.

(540) **ET (and logo)**

(732) Bo Xu of Farm 50A, Makeni, Lusaka, Zambia.

(111) 1676/2023; (151) 02.10.2023.

(511) Int. Cl.5.

(540) **CROWN**

(732) Sineria Holland B.V of Randwycksingel 20-A015 6229 Ee Maastricht, Netherlands.

(111) 1677/2023; (151) 02.10.2023.

(511) Int. Cl.5.

(540) **MOFARNO**

(732) Sineria Holland B.V of Randwycksingel 20-A015 6229 Ee Maastricht, Netherlands.

(111) 1698/2023; (151) 06.10.2023.

(511) Int. Cl.29.

(540) **MILKMAN**

(732) Dairy Gold Limited of Plot No. 29381, Nampundwe Road, Light Industrial Area, P.O Box 30824, , Lusaka, Zambia.

(111) 1705/2023; (151) 09.10.2023.

(511) Int. Cl.16.

(540) **SAP (and logo)**

(732) SAP SE of Dietmar-Hopp-Allee 16 69190 Walldorf, Germany.

(111) 1706/2023; (151) 09.10.2023.

(511) Int. Cl.16.

(540) **SAP**

(732) SAP SE of Dietmar-Hopp-Allee 16 69190 Walldorf, Germany.

(111) 1707/2023; (151) 09.10.2023.

(511) Int. Cl.16.

(540) **SAP HANA**

(732) SAP SE of Dietmar-Hopp-Allee 16 69190 Walldorf, Germany.

(111) 1715/2023; (151) 10.10.2023.

(511) Int. Cl.16.

(540) **Media Innovation Programme**

(732) Nigeria Communications Plc of MTN Plaza, No.1 Awolowo Road, falomo, Ikoyi , Lagos, Nigeria.

(111) 1717/2023; (151) 10.10.2023.

(511) Int. Cl.9.

(540) **MIP**

(732) Nigeria Communications Plc of MTN Plaza, No.1 Awolowo Road, falomo, Ikoyi , Lagos, Nigeria.

(111) 1839/2023; (151) 23.10.2023.

(511) Int. Cl.5.

(540) **AMDOCS**

(732) Sineria Holland B.V of Randwycksingel 20-A015 6229 EE Maastricht, Netherlands.

(111) 1840/2023; (151) 23.10.2023.

(511) Int. Cl.5.

(540) **ATTITUDE 80 SC**

(732) Sineria Holland B.V of Randwycksingel 20-A015 6229 EE Maastricht, Netherlands.

(111) 1841/2023; (151) 23.10.2023.

(511) Int. Cl.5.

(540) **BRONOCOT**

(732) Sineria Holland B.V of Randwycksingel 20-A015 6229 EE Maastricht, Netherlands.

(111) 1842/2023; (151) 23.10.2023.

(511) Int. Cl.5.

(540) **BUFFALO**

(732) SINERIA HOLLAND B.V of Randwycksingel 20-A015 6229 EE Maastricht, Netherlands.

(111) 1843/2023; (151) 23.10.2023.

(511) Int. Cl.5.

(540) **CYRUS VAN**

(732) Sineria Holland B.V of Randwycksingel 20-A015 6229 EE Maastricht, Netherlands.

(111) 1844/2023; (151) 23.10.2023.

(511) Int. Cl.5.

(540) **DALOT**

(732) Sineria Holland B.V of Randwycksingel 20-A015 6229 EE Maastricht, Netherlands.

(111) 1845/2023; (151) 23.10.2023.

(511) Int. Cl.5.

(540) **EMBARK**

(732) Sineria Holland B.V of Randwycksingel 20-A015 6229 Ee Maastricht, Netherlands.

(111) 1846/2023; (151) 23.10.2023.

(511) Int. Cl.5.

(540) **MARCH**

(732) Sineria Holland B.V of Randwycksingel 20-A015 6229 Ee Maastricht, Netherlands.

(111) 1847/2023; (151) 23.10.2023.

(511) Int. Cl.5.

(540) **MAXIMUS**

(732) Sineria Holland B.V of Randwycksingel 20-A015 6229 Ee Maastricht, Netherlands.

(111) 1848/2023; (151) 23.10.2023.

(511) Int. Cl.5.

(540) **OKIDA**

(732) Sineria Holland B.V of Randwycksingel 20-A015 6229 Ee Maastricht, Netherlands.

(111) 1849/2023; (151) 23.10.2023.

(511) Int. Cl.5.

(540) **OTHELLO TOP**

(732) Sineria Holland B.V of Randwycksingel 20-A015 6229 Ee Maastricht, Netherlands.

(111) 1850/2023; (151) 23.10.2023.

(511) Int. Cl.5.

(540) **PREVAIL-P**

(732) Sineria Holland B.V of Randwycksingel 20-A015 6229 Ee Maastricht, Netherlands.

(111) 1851/2023; (151) 23.10.2023.

(511) Int. Cl.5.

(540) **SPENCER**

(732) Sineria Holland B.V of Randwycksingel 20-A015 6229 Ee Maastricht, Netherlands.

(111) 1864/2023; (151) 26.10.2023.

(511) Int. Cl.30.

(540) **Loxo (and logo)**

(732) Parrogate Ginneries Limited of Plot No. 397/A/D, Makeni, Lusaka, Zambia.

(111) 1865/2023; (151) 26.10.2023.

(511) Int. Cl.30.

(540) **Nile**

(732) Parrogate Ginneries Limited of Plot No. 397/A/D, Makeni, Lusaka, Zambia.

(111) 1866/2023; (151) 26.10.2023.

(511) Int. Cl.30.

(540) **Bigbite**

(732) Parrogate Ginneries Limited of Plot No. 397/A/D, Makeni, Lusaka, Zambia.

(111) 1979/2023; (151) 31.10.2023.

(511) Int. Cl.16.

(540) AIFEEL (and logo)

(732) AIFEEL Investments Limited of Plot 10095, Off Mumbwa Road, Chinika Industrial Area, Lusaka, Zambia.

(111) 2061/2023; (151) 10.11.2023.

(511) Int. Cl.29.

(540) **JESS**

(732) Acacia Food & Beverages Limited of Plot No. 8492 Lumumbashi Road, P.O. Box 35879, Lusaka, Zambia.

(111) 2064/2023; (151) 10.11.2023.

(511) Int. Cl.30.

(540) **MUSUVA & Logo**

(732) Brandhold Investments of 2 Pauls Close, Glen Lome, Harare, Zimbabwe.

(111) 2086/2023; (151) 15.11.2023.

(511) Int. Cl.32.

(540) **GROOVY DIP**

(732) Ebee's Investments Limited of Near Old Post News Paper, Light Industrial Area, 0/0, 10526, Chandwe Musonda Road, Lusaka, Zambia.

(111) 2221/2023; (151) 01.12.2023.

(511) Int. Cl.5.

(540) **ALBECTIN**

(732) Ashish Life Science Pvt Limited of 1101-1103, Aston, Sundervan Complex, Achutrao Patwardhan Marg (lokhandwala Road), Andheri (West), Mumbai-400053, India.

(111) 2222/2023; (151) 01.12.2023.

(511) Int. Cl.5.

(540) **ZEROKRIM**

(732) Ashish Life Science Pvt Limited of 1101-1103, Aston, Sundervan Complex, Achutrao Patwardhan Marg (lokhandwala Road), Andheri (West), Mumbai-400053, India.

(111) 2223/2023; (151) 01.12.2023.

(511) Int. Cl.5.

(540) **MURTRYP**

(732) Ashish Life Science Pvt Limited of 1101-1103, Aston, Sundervan Complex, Achutrao Patwardhan Marg (lokhandwala Road), Andheri (West), Mumbai-400053, India.

(111) 2224/2023; (151) 01.12.2023.

(511) Int. Cl.5.

(540) **FENACURE**

(732) Ashish Life Science Pvt Limited of 1101-1103, Aston, Sundervan Complex, Achutrao Patwardhan Marg (lokhandwala Road), Andheri (West), Mumbai-400053, India.

(111) 2225/2023; (151) 01.12.2023.

(511) Int. Cl.5.

(540) **BUTACURE**

(732) Ashish Life Science Pvt Limited of 1101-1103, Aston, Sundervan Complex, Achutrao Patwardhan Marg (lokhandwala Road), Andheri (West), Mumbai-400053, India.

(111) 2226/2023; (151) 01.12.2023.

(511) Int. Cl.5.

(540) **MILKYWAY**

(732) Ashish Life Science Pvt Limited of 1101-1103, Aston, Sundervan Complex, Achutrao Patwardhan Marg (lokhandwala Road), Andheri (West), Mumbai-400053, India.

STATUTORY NOTICES UNDER THE TRADE MARKS ACT (CAP. 401)

ALTERATION OF REGISTERED TRADE MARKS (TH/CA)

NOTICE IS HEREBY GIVEN, in terms of Section 40 of the Trade Marks Act Cap. 401 of the Laws of Zambia, that application has been made by the person, natural or body corporate, mentioned in Code (732) for alteration of the trade mark registered under the number indicated in Code (111) to the form appearing in Code (540).

Any person who has grounds of opposition to such alteration may, within two months of publication hereof, file with the Registrar of Trade Marks a Notice of Opposition on Form TM No. 6.

(111) 1093/2014; (151) 09.07.2014.

(732)(750) Parrogate Ginneries Limited, Plot No. 397A, Off Kafue Road, P.O Box 50854, Lusaka
Zambia.

(511) Int.Cl.29.

(510) Pure cooking oil made from soya beans.

(526) Trade rights subsist in the word '**WHITE GOLD**', as such, and the get-up of the trade mark as a whole, while the rest of the wording and figurative elements are descriptive non-trade mark matter.

(541) **WHITE GOLD Label.**

(111) 769/2014; (151) 09.07.2014.

(732)(750) Parrogate Ginneries Limited, Plot No. 397A, Off Kafue Road, P.O Box 50854, Lusaka
Zambia.

(511) Int.Cl.29.

(510) Pure cooking oil made from soya beans.

(526) The mark consists of the word '**ZAMGOLD**', while the rest of the wording is descriptive and therefore non-trademark matter.

(540)

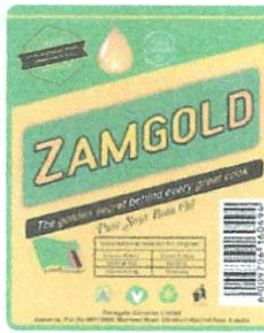

STATUTORY NOTICES UNDER THE TRADE MARKS ACT (CAP. 401)

TRADE MARK REGISTRATIONS RENEWED FOR FEBRUARY, 2024. (ND)

THE FOLLOWING trade mark registrations listed below have been renewed in accordance with Section 25 of the Trade Marks Act for 14 years with effect from the date indicated in Code (156).

(111) 235/1961; (156) 14.02.2024.

(511) Int. Cl. 5.

(540) **DISOPHROL**

(732) Merck Sharp & Dohme Corp.

(111) 244/1961; (156) 16/02/2024.

(511) Int. Cl.31.

(540) **ASGROW**

(732) MONSANTO TECHNOLOGY LLC.

(111) 263/1961; (156) 21.02.2024.

(511) Int. Cl.30.

(540) **JOKO**

(732) Ekaterra Group IP Holdings B.V.

(111) 260/1961; (156) 21/02/2024.

(511) Int. Cl. 5.

(540) **MENTHOLATUM DEEP HEAT RUB**

(732) The Mentholatum Company Limited.

(111) 71/1975; (156) 18.02.2024.

(511) Int. Cl.24.

(540) **JOHNSON'S**

(732) Johnson & Johnson

(111) 72 /1975; (156) 20.02/2024.

(511) Int. Cl. 3.

(540) **MONCLER**

(732) MONCLER S.P.A.

(111) 70/2003; (156) 06.02.2024.

(511) Int. Cl. 31.

(540) **TEMPTATIONS**

(732) Mars, Incorporated

(111) 94/2003; (156) 25.02.2024

(511) Int. Cl. 29.

(540) **LOGO**

(732) Societe Des Produits Nestle S.A.,

(111) 97/2003; (156) 25.02.2024.

(511) Int. Cl. 16.

(540) **PRIORITY BANKING**

(732) Standard Chartered Plc

(111) 108/2003; (156) 27.02.2024.

(511) Int. Cl. 16

(540) **SOUTH AFRICAN**

(732) South Africa Airways (Proprietary) Limited.

(111) 109/2003; (156) 27.02.2024.

(511) Int. Cl. 16.

(540) **Logo only**

(732) South African Airways (Proprietary) Limited

(111) 110/2003; (156) 27.02.2024.

(511) Int. Cl. 16.

(540) **Logo only**

(732) South African Airways (Proprietary) Limited

(111) 110 /2003; (156) 27.02.2024.

(511) Int. Cl. 16.

(540) **Logo only**

(732) South African Airways (Proprietary) Limited.

(111) 111/2003; (156) 27.02.2024.

(511) Int. Cl. 16.

(540) **SOUTH AFRICAN AIRWAYS**

(732) South African Airways (Proprietary) Limited.

(111) 112 /2003; (156) 05.01.2024.

(511) Int. Cl.16.

(540) **SAA**

(732) South African Airways (Proprietary) Limited

(111) 173/2017; (156) 08.02.2024.
(511) Int. Cl. 13.
(540) **AXXIS DEVICE**
(732) OMNIA HOLDINGS LIMITED

(111) 182/2017; (156) 08.02.2024.
(511) Int. Cl. 30.
(540) **3 Half Suns logo**
(732) Tsogo Sun (Proprietary) Limited.

(111) 181/2017; (156) 08.02.2024.
(511) Int. Cl.29.
(540) **3 Half Suns logo**
(732) Tsogo Sun (Proprietary) Limited

111) 178/2017; (156) 08.02.2024.
(511) Int. Cl.8.
(540) **3 Half Suns logo**
(732) Tsogo Sun (Proprietary) Limited

111) 179/2017; (156) 08.02.2024.
(511) Int. Cl.16.
(540) **3 Half Suns logo**
(732) Tsogo Sun (Proprietary) Limited

111) 180/2017; (156) 08.02.2024.
(511) Int. Cl.21.
(540) **3 Half Suns logo**
(732) Tsogo Sun (Proprietary) Limited

111) 189/2017; (156) 09.02.2024.
(511) Int. Cl.5.
(540) **MULTIDIP**
(732) Virbac RSA (Proprietary) Limited

111) 186/2017; (156) 09.02.2024.

(511) Int. Cl.5.

(540) **TROIKAA**

(732) Troikaa Pharmaceuticals Limited

111) 188/2017; (156) 09.02.2024.

(511) Int. Cl.16.

(540) **DIRECT PAY ONLINE THE HOME OF ONLINE PAYMENT Logo**

(732) 3G Direct Pay Limited

(111) 190/2017; (156) 09.02.2024.

(511) Int. Cl.32.

(540) **FRUTAZ**

(732) Aiman Comercio Geral, Lda

(111) 200/2017; (156) 13.02.2024.

(511) Int. Cl.34.

(540) **PEONY DELUXE Logo**

(732) Nanyang Brothers Tobacco Company Limited

(111) 218/2017; (156) 13.02.2024.

(511) Int. Cl.32.

(540) **PEPSI**

(732) PepsiCo, Inc

(111) 197/2017; (156) 13.02.2024.

(511) Int. Cl.10.

(540) **AVIBELA (FIGURATIVE)**

(732) Medicine360

(111) 198/2017; (156) 13.02.2024.

(511) Int. Cl.9.

(540) **STYLO**

(732) Pepkor Trading Proprietary Limited

(111) 220 /2017; (156) 15.02.2024.

(511) Int. Cl. 32.

(540) **QURE**

(732) Bigtree Beverages Limited

(111) 221 /2017; (156) 15.02.2024.

(511) Int. Cl. 32.

(540) **UTUMI**

(732) Bigtree Beverages Limited

(111) 222 /2017; (156) 15.02.2024.

(511) Int. Cl. 32.

(540) **FUEL-ENERGY**

(732) Bigtree Beverages Limited

(111) 225 /2017; (156) 15.02.2024.

(511) Int. Cl. 5.

(540) **GROWELL**

(732) Royal Oak Limited

(111) 226 /2017; (156) 15.02.2024.

(511) Int. Cl. 30.

(540) **GROWELL**

(732) Royal Oak Limited

(111) 228 /2017; (156) 17.02.2024.

(511) Int. Cl. 7.

(540) **WHIRLPOOL**

(732) Whirlpool Properties, Inc

(111) 231 /2017; (156) 17.02.2024.

(511) Int. Cl. 11.

(540) **WHIRLPOOL Logo**

(732) Whirlpool Properties, Inc

(111) 229 /2017; (156) 17.02.2024.

(511) Int. Cl. 11.

(540) **WHIRLPOOL**

(732) Whirlpool Properties, Inc

(111) 240 /2017; (156) 21.02.2024.

(511) Int. Cl. 09.

(540) **WILLARD**

(732) Autox (PTY) Limited

(111) 243 /2017; (156) 21.02.2024.

(511) Int. Cl. 01.

(540) **KIWI & BIRD DESIGN**

(732) S.C Johnson & Son, Inc

((111) 245 /2017; (156) 21.02.2024.

(511) Int. Cl. 03.

(540) **KIWI & BIRD DESIGN**

(732) S.C Johnson & Son, Inc

(111) 246 /2017; (156) 21.02.2024.

(511) Int.Cl.05.

(540) **KIWI & BIRD DESIGN**

(732) S.C Johnson & Son, Inc

(111) 247 /2017; (156) 21.02.2024.

(511) Int. Cl. 21.

(540) **KIWI & BIRD DESIGN**

(732) S.C Johnson & Son, Inc

(111) 248/2017; (156) 21.02.2024.

(511) Int. Cl. 26.

(540) **KIWI & BIRD DESIGN**

(732) S.C Johnson & Son, Inc

(111) 249 /2017; (156) 21.02.2024.

(511) Int. Cl. 01.

(540) **KIWI & BIRD DESIGN**

(732) S.C Johnson & Son, Inc

(111) 252 /2017; (156) 21.02.2024.

(511) Int. Cl. 05.

(540) **KIWI & BIRD DESIGN**

(732) S.C Johnson & Son, Inc

(111) 253 /2017; (156) 21.02.2024.

(511) Int. Cl. 21.

(540) **KIWI & BIRD DESIGN**

(732) S.C Johnson & Son, Inc

(111) 254 /2017; (156) 21.02.2024.

(511) Int. Cl. 26.

(540) **KIWI & BIRD DESIGN**

(732) S.C Johnson & Son, Inc

(111) 255 /2017; (156) 21.02.2024.

(511) Int. Cl. 01.

(540) **KIWI TIN - GRAY WITH BOWTIE**

(732) S.C Johnson & Son, Inc

(111) 256 /2017; (156) 21.02.2024.

(511) Int. Cl. 02.

(540) **KIWI TIN - GRAY WITH BOWTIE**

(732) S.C Johnson & Son, Inc

(111) 258 /2017; (156) 21.02.2024.

(511) Int. Cl. 05.

(540) **KIWI TIN - GRAY WITH BOWTIE**

(732) S.C Johnson & Son, Inc

(111) 259 /2017; (156) 21.02.2024.

(511) Int. Cl. 21.

(540) **KIWI TIN - GRAY WITH BOWTIE**

(732) S.C Johnson & Son, Inc

(111) 260 /2017; (156) 21.02.2024.

(511) Int. Cl. 26.

(540) **KIWI TIN - GRAY WITH BOWTIE**

(732) S.C Johnson & Son, Inc

(111) 257 /2017; (156) 21.02.2024.

(511) Int. Cl. 3.

(540) **KIWI TIN - GRAY WITH BOWTIE**

(732) S.C Johnson & Son, Inc

(111) 250 /2017; (156) 21.02.2024.

(511) Int. Cl. 2.

(540) **KIWI BIRD DESIGN**

(732) S.C Johnson & Son, Inc

(111) 272/2017; (156) 22.02.2024.

(511) Int. Cl. 29.

(540) **BOLA**

(732) Yoyo Foods Limited

111) 272/2017; (156) 22.02.2024.

(511) Int. Cl. 29.

(540) **BOLA**

(732) Yoyo Foods Limited

(111) 273 /2017; (156) 22.02.2024.

(511) Int. Cl. 30.

(540) **CHEEZ MANIA**

(732) Yoyo Foods Limited.

(111) 274 /2017; (156) 22.02.2024.

(511) Int. Cl. 29.

(540) **CHOCO DIPPS**

(732) Yoyo Foods Limited.

(111) 275/2017; (156) 22.02.2024.
(511) Int. Cl. 30.
(540) **KOKOLIKO**
(732) Yoyo Foods Limited.

(111) 276 /2017; (156) 22.02.2024.
(511) Int. Cl. 30.
(540) **LALA LOOPS TOMATO**
(732) Yoyo Foods Limited.

(111) 290 /2017; (156) 23.02.2024.
(511) Int. Cl. 32.
(540) **JOOSIT**
(732) Dairy Gold Limited(ZM)

(111) 295 /2017; (156) 23.02.2024.
(511) Int. Cl. 29.
(540) **CABANA Logo**
(732) Lactalis South Africa (Pty) Limited.

(111) 296 /2017; (156) 23.02.2024.
(511) Int. Cl. 32.
(540) **CABANA**
(732) Lactalis South Africa (Pty) Limited.

(111) 297 /2017; (156) 23.02.2024.
(511) Int. Cl. 29.
(540) **CABANA Logo**
(732) Lactalis South Africa (Pty) Limited.

(111) 298 /2017; (156) 23.02.2024.
(511) Int. Cl. 32.
(540) **CABANA Logo**
(732) Lactalis South Africa (Pty) Limited.
Ltd

(111) 289 /2017; (156) 23.02.2024.
(511) Int. Cl. 29.

(540) **CREEMIT**

(732) Dairy Gold Limited (ZM)

(111) 299/2017; (156) 24.02.2024

(511) Int. Cl. 32.

(540) **REBOOST ENERGY**

(732) Little Green Beverages Proprietary Limited, T/A The Beverage Company

(111) 303/2017; (156) 27.02.2024.

(511) Int. Cl. 9.

(540) **SEBANG Logo**

(732) Sebang Global Battery Co., Ltd

(111) 311/2017; (156) 28.02.2024.

(511) Int. Cl. 1.

(540) **FALCON**

(732) ETG Inputs Holdco Ltd

((111) 306/2017; (156) 28.02.2024.

(511) Int. Cl. 32.

(540) **MOJO**

(732) Bigtree Beverage Limited

(111) 318/2017; (156) 28.02.2024.

(511) Int. Cl. 5.

(540) **OROFER**

(732) Emcure Pharmaceuticals Limited

111) 315/2017; (156) 28.02.2024.

(511) Int. Cl. 5.

(540) **LOMOH**

(732) Emcure Pharmaceuticals Limited

111) 316/2017; (156) 28.02.2024.

(511) Int. Cl. 5.

(540) **ASOMEX**

(732) Emcure Pharmaceuticals Limited

111) 317/2017; (156) 28.02.2024.

(511) Int. Cl. 5.

(540) **ENCIFER**

(732) Emcure Pharmaceuticals Limited

(111) 319/2017; (156) 28.02.2024.

(511) Int. Cl. 5.

(540) **C-TRI**

(732) Emcure Pharmaceuticals Limited

(111) 321/2017; (156) 28.02.2024.

(511) Int. Cl. 5.

(540) **VIFEX**

(732) Emcure Pharmaceuticals Limited

(111) 322/2017; (156) 28.02.2024.

(511) Int. Cl. 5.

(540) **CIPROBIOTIC**

(732) Emcure Pharmaceuticals Limited

(111) 320/2017; (156) 28.02.2024.

(511) Int. Cl. 5.

(540) **PANPURE**

(732) Emcure Pharmaceuticals Limited

(111) 314/2017; (156) 28.02.2024.

(511) Int. Cl. 6.

(540) **BSI STEEL Logo**

(732) BSI Steel Ltd (ZA)

STATUTORY NOTICES UNDER THE TRADE MARKS ACT (CAP. 401)

TRADE MARK REGISTRATIONS LAPSED FOR NON-RENEWAL. (MM)

(111) 1558/1008 (156) 20.1.2024

(511) Int. Cl. 12

(540) **DUNLOP**

(732) Sumitomo Rubber Industries, Ltd

(111) 7, 8/1961 (156) 4.1.2024

(511) Int. Cl. 9, 11

(540) **ELECTROLUX**

(732) Aktiebolaget Electrolux

(111) 14/1961 (156) 5.1.2024

(511) Int. Cl. 11

(540) **KELVINATOR**

(732) Electrolux Home Products, Inc.

(111) 152/1961 (156) 27.1.2024

(511) Int. Cl. 1

(540) **CELCON**

(732) CNA holdings, Inc.

(111) 14/1975 (156) 8.1.2024

(511) Int. Cl. 5

(540) **BRONCHICUM**

(732) A. Nattermann & CIE GmbH

(111) 24/1975 (156) 21.1.2024

(511) Int. Cl. 32

(540) **ENO**

(732) GlaxoSmithKline Consumer Healthcare (UK) IP Limited

(111) 28/1975 (156) 24.1.2024

(511) Int. Cl. 3

(540) **ASEPSO**

(732) Unilever plc

(111) 30, 31/1975 (156) 24.1.2024

(511) Int. Cl. 3

(540) **SUNBEAM WITH POWERSHINE, SUNBEAM WITH WONDERSHINE**

(732) Reckitt & Colman (Overseas) Limited

(111) 38/1975 (156) 30.1.2024

(511) Int. Cl. 3

(540) **TEXWOOD**

(732) Texwood limited

(111) 2/1989 (156) 12.1.2024

(511) Int. Cl. 7

(540) **WEMCO**

(732) FLSmidth A/S

(111) 3/1989 (156) 12.1.2024

(511) Int. Cl. 17

(540) **WEMCO**

(732) GL & V Management Kft

(111) 6/1989 (156) 20.1.2024

(511) Int. Cl. 32

(540) **BERGEDORF**

(732) Holsten-Brauerei AG

(111) 5/2003 (156) 14.1.2024

(511) Int. Cl. 16

(540) **PLAN**

(732) Plan International Inc

(111) 7, 8/2003 (156) 21.1.2024

(511) Int. Cl. 30

(540) **NO NAME, PICK 'N PAY**

(732) Pick 'N pay Retailers (Proprietary) Limited

(111) 21/2003 (156) 23.1.2024

(511) Int. Cl. 29

(540) **ZAMCHEESE**

(732) Zambeef Products Plc

(111) 23, 24/2003 (156) 24.1.2024

(511) Int. Cl. 29, 30
(540) **CROWN NATIONAL**
(732) Bidvest International Limited

(111) 42/2003 (156) 28.1.2024
(511) Int. Cl. 9
(540) **CITILITES**
(732) Continental Outdoor M Africa (Pty) Limited

(111) 43/2003 (156) 28.1.2024
(511) Int. Cl. 16
(540) **BUILD IT**
(732) The Spar Group Limited

(111) 48/2003 (156) 28.1.2024
(511) Int. Cl. 3
(540) **HAIRWORKS**
(732) Unilever Plc

(111) 24/2004 (156) 14.1.2024
(511) Int. Cl. 32
(540) **LEVEL**
(732) V&S Vin & Sprit Aktiebolag (Publ)

(111) 4, 5/2017 (156) 5.1.2024
(511) Int. Cl. 1, 5
(540) **FLUMET**
(732) UPL Corporation Limited

(111) 11, 12/2017 (156) 9.1.2024
(511) Int. Cl. 29, 30
(540) **ZOTT MILK TIGER (COLOUR)**
(732) Zott SE & Co. KG

(111) 18, 19, 20 /2017 (156) 10.1.2024
(511) Int. Cl. 1, 5, 9
(540) **VIROSEQ**
(732) Abbott Molecular Inc.

(111) 36/ 2017 (156) 10.1.2024
(511) Int. Cl. 16

(540) **BAROTSE ROYAL ESTABLISHMENT**

(732) Barotse Royal Establishment

(111) 41 /2017 (156) 6.1.2024

(511) Int. Cl. 29

(540) **SAZA COOKING OIL**

(732) Saza Oil Company Limited

(111) 42,43,44,45/2017 (156) 6.1.2024

(511) Int. Cl. 7,9,12,19

(540) **SUNLINE**

(732) Sun Line International Logistics Co., Limited

(111) 48/2017; (156) 16.01.2024.

(511) Int. Cl. 5.

(540) **MOFIX.**

(732) Rotam Limited

(111) 49/2017; (156) 16.01.2024.

(511) Int. Cl.30.

(540) **YAMENE CRAZY CORN LABEL**

(732) Yamene Naks Investments Limited.

(111) 51, 52, 53/2017; (156) 17.01.2024.

(511) Int. Cl.16.

(540) **ZAM BOOKS, IMS ZAMBIA , WONDER BOOKS**

(732) Ims Zambia Paper Industries Ltd

(111) 54, 55, 56, 57, 58, 59, 60, 61, 62, 63 /2017; (156) 17/01/2024.

(511) Int. Cl. 9, 16 .

(540) **ZANACO XPRESS MONEY, ZANACO XPRESS CASH, ZANACO
XPRESS KASH, ZANACO XPRESSCASH, ZANACO CASH XPRESS**

(732) Zambia National Commercial Bank Plc.

(111) 64, 65, 66, 67/2017; (156) 18.01.2024.

(511) Int. Cl.28, 16.

(540) **'M' SIMBI FEMALE DEVICE WITH STARS, 'M' SIMBI NATURALLY
BEAUTIFUL AND FEMALE DEVICE WITH TAGLINE**

(732) Maingala Moono

(111) 78/2017; (156) 19.01/2024.

(511) Int. Cl. 16.

(540) **KINGSLAND CITY**

(732) Sunshare Investments Limited

(111) 79/2017; (156) 19.01.2024.

(511) Int. Cl. 32.

(540) **24 SEVEN**

(732) Twenty Four Seven Stores and General Trading Limited

(111) 80/2017; (156) 20.01.2024.

(511) Int. Cl. 16.

(540) **LOOKNA**

(732) Lookna Inc.

(111) 81/2017; (156) 20.01.2024.

(511) Int. Cl. 6.

(540) **LSF-LIGHT STEEL FRAME**

(732) Zambezi Roofing & Steel.

(111) 82, 83/2017; (156) 20.01.2024.

(511) Int. Cl. 16, 25.

(540) **TAX ONLINE LOGO**

(732) Zambia Revenue Authority.

(111) 85/2017; (156) 20.01.2024.

(511) Int. Cl. 7.

(540) **DAILY 55'**

(732) Samsung Electronics Co.; Ltd

(111) 88/2017; (156) 23.01.2024.

(511) Int. Cl. 25.

(540) **BAROTSE ROYAL ESTABLISHMENT**

(732) Barotse Royal Establishment

(111) 91, 92, 93/2017; (156) 23.01.2024.

(511) Int. Cl. 30.

(540) **AGOGO'S MINI CHOC CHIP LOAF, AGOGO'S BURGER ROLLS,
AGOGO'S CHOCOLATE CHIP LOAF**

(732) Granny's Bakery Limited.

(111) 101, 103/2017; (156) 25.01.2024.

(511) Int. Cl. 25.

(540) **VF, VF WE FIT YOUR LIFE**

(732) V.F. Corporation.

(111) 104, 105/2017; (156) 25.01.2024.

(511) Int. Cl. 30.

(540) **AGOGO'S ROUND LOAF, AGOGO'S RAISIN BREAD**

(732) Granny's Bakery Limited.

(111) 106/2017; (156) 26.01.2024.

(511) Int. Cl. 16.

(540) **FIRST HILL TICKETS**

(732) First Hill Enterprises

(111) 107/2017; (156) 26.01.2024.

(511) Int. Cl. 30.

(540) "Signature Snacks & Logo"

(732) Signature Snacks L.L.C.

(111) 111 /2017; (156) 27.01.2024.

(511) Int. Cl. 12.

(540) **PLAIN ROLLER PLUS**

(732) Bridgestone Licensing Services, Inc..

(111) 112, 113, 114, 115, 116, 117/2017; (156) 27.01.2024.

(511) Int. Cl. 4, 12.

(540) **FUKUKAWA, SIMBA, OMAX, TAG**

(732) Simba Auto Spares Limited

(111) 121/2017; (156) 30.01.2024.

(511) Int. Cl. 30.

(540) **GO-GOES (CHOCOLATE), GO-GOES (ORIGINAL)**

(732) Royal Biscuit Limited

(111) 126/2017; (156) 31.01.2024.

(511) Int. Cl. 2.

(540) **DIAMOND**

(732) Akzo Nobel Coatings International B.V.

(111) 127/2017; (156) 31.01.2024.

(511) Int. Cl. 11.

(540) **LIXIL**

(732) LIXIL Corporation.

STATUTORY NOTICES UNDER THE TRADE MARKS ACT (CAP. 401)

TRADE MARK REGISTRATIONS NOT RENEWED FOR FEBRUARY, 2024. (KC)

NOTICE IS HEREBY GIVEN, in terms of Regulation 67, of the Trade Marks Regulations that the under mentioned trade marks will be removed from the Registrar unless the prescribed renewal fee is paid on Form TM No. 12 together with an additional fee on Form TM. No. 13 within one month from the date of this notice.

(111) 2423/1926; (156) 22.02.2024.

(511) Int. Cl. 3.

(540) **NORMACOL**

(732) Norgine Limited

(111) 1593/1958; (156) 23/02/2024.

(511) Int. Cl.4.

(540) **CALTEX**

(732) Chevron Intellectual Property LLC

(111) 192/1961; (156) 04.02.2024.

(511) Int. Cl.1.

(540) **OXITOL**

(732) Shell International Petroleum Company Ltd

(111) 193/1961; (156) 04.02.2024.

(511) Int. Cl.1.

(540) **DIOXITOL**

(732) Shell International Petroleum Company Ltd

(111) 192/1961; (156) 04.02.2024.

(511) Int. Cl.1.

(540) **TRIOXITOL**

(732) Shell International Petroleum Company Ltd

(111) 64/1975; (156) 14.02.2024.

(511) Int. Cl.7.

(540) **ZANUSSI**

(732) Electrolux Zanussi SPA

111) 65/1975; (156) 14.02.2024.

(511) Int. Cl.9.

(540) **ZANUSSI**

(732) Electrolux Zanussi SPA

111) 64/1975; (156) 14.02.2024.

(511) Int. Cl.7.

(540) **ZANUSSI**

(732) Electrolux Zanussi SPA

(111) 66/2003; (156) 04.02.2024.

(511) Int. Cl. 5.

(540) **DEVICE**

(732) Societe Des Products Nestle S.A.

(111) 67/2003; (156) 04.02.2024.

(511) Int. Cl. 29.

(540) **DEVICE**

(732) Societe Des Products Nestle S.A..

(111) 65/2003; (156) 04.02.2024.

(511) Int. Cl. 1.

(540) **CALCI-N**

(732) Societe Des Products Nestle S.A

(111) 071/2003; (156) 06.02.2024.

(511) Int. Cl. 9.

(540) **KULULA**

(732) Comair Limited

(111) 072 /2003; (156) 06.02.2024.

(511) Int. Cl. 12.

(540) **KULULA**

(732) Comair Limited

(111) 073/2003; (156) 06.02.2024.

(511) Int. Cl. 16.

(540) **KULULA**

(732) Comair Limited

(111) 074/2003; (156) 06.02.2024.

(511) Int. Cl. 25.

(540) **KULULA**

(732) Comair Limited

(111) 173/2017; (156) 08.02.2024.

(511) Int. Cl. 13.

(540) **ZEMRIK**

(732) Ares Trading S.A.

(111) 88/2003; (156) 12.02.2024.

(511) Int. Cl. 33.

(540) **SMIRNOFF**

(732) Diageo North America, Inc.

(111) 89/2003; (156) 12.02.2024.

(511) Int. Cl. 33.

(540) **SMIRNOFF**

(732) Diageo North America, Inc

(111) 78/2003; (156) 12.02.2024.

(511) Int. Cl. 30.

(540) **BUTTER SCOTCH MILK**

(732) Usman Confectioneries Limited

111) 84/2003; (156) 18.02.2024.

(511) Int. Cl.11.

(540) **DEVICE**

(732) Daewoo Electronic Corporation

111) 82/2003; (156) 18.02.2024.

(511) Int. Cl.7.

(540) **DEVICE**

(732) Daewoo Electronic Corporation

111) 83/2003; (156) 18.02.2024.

(511) Int. Cl..

(540) **DEVICE**

(732) Daewoo Electronic Corporation

111) 84/2003; (156) 18.02.2024.

(511) Int. Cl.11.
(540) **DEVICE**
(732) Daewoo Electronic Corporation

(111) 85/2003; (156) 18.02.2024.
(511) Int. Cl.9.
(540) **TELECEL**
(732) Telecel International Limited

(111) 86/2003; (156) 18.02.2024.
(511) Int. Cl.9.
(540) **TELECEL**
(732) Telecel International Limited

(111) 91/2003; (156) 21.02.2024.
(511) Int. Cl.32.
(540) **ROSEGA**
(732) Johnson & Johnson

(111) 93/2003; (156) 25.02.2024.
(511) Int. Cl.5.
(540) **OPTANZA**
(732) Astrazeneca Uk Limited

(111) 101/2003; (156) 25.02.2024.
(511) Int. Cl.16.
(540) **SMARTCREDIT**
(732) Standard Chartered Plc

(111) 106/2003; (156) 26.02.2024.
(511) Int. Cl.12.
(540) **MAYBACH**
(732) Mercedes-Benz Group AG

(111) 107/2003; (156) 25.02.2024.
(511) Int. Cl.12.
(540) Logo only
(732) Mercedes-Benz Group AG

(111) 113 /2003; (156) 28.02.2024.

(511) Int. Cl. 32.

(540) **THRILL**

(732) N.R Investments Limited (ZM)

(111) 113 /2003; (156) 28.02.2024.

(511) Int. Cl. 32.

(540) **THRILL**

(732) N.R Investments Limited (ZM)

(111) 114 /2003; (156) 28.02.2024.

(511) Int. Cl. 32.

(540) **RUSH**

(732) N.R Investments Limited (ZM)

(111) 115 /2003; (156) 28.02.2024.

(511) Int. Cl. 32.

(540) **ZOOBA**

(732) N.R. Investments Limited

(111) 116 /2003; (156) 28.02.2024.

(511) Int. Cl. 32.

(540) **ZOOM**

(732) N.R. Investments Limited

(111) 133 /2017; (156) 01.02.2024.

(511) Int. Cl. 16.

(540) **TRIPLE S RANCH**

(732) Triple S Ranch Limited

111) 134 /2017; (156) 01.02.2024.

(511) Int. Cl. 16.

(540) **MOVER**

(732) Smollan Holdings (Pty) Limited

(111) 135/2017; (156) 01.02.2024.

(511) Int. Cl. 16.

(540) **WIZ**

(732) Micro Link Technologies Limited

(111) 136 /2017; (156) 02.02.2024.

(511) Int. Cl. 16.

(540) **PRINCESSBET & Logo**

(732) SXM Management Zambia Limited

(111) 137 /2017; (156) 02.02.2024.

(511) Int. Cl. 32.

(540) **JAMAICAN GINGER**

(732) Acacia Food and Beverages Limited

(111) 142 /2017; (156) 06.02.2024.

(511) Int. Cl. 32.

(540) **SWIFT LIMON**

(732) Californian Beverages Limited

(111) 160 /2017; (156) 06.02.2024.

(511) Int. Cl. 32.

(540) **HUMMING BIRD ORANGE**

(732) Californian Beverages Limited

(111) 158 /2017; (156) 06.02.2024.

(511) Int. Cl. 32.

(540) **APPLEMAX**

(732) Californian Beverages Limited

(111) 162 /2017; (156) 06.02.2024.

(511) Int. Cl. 32.

(540) **HUMMING BIRD ORANGE**

(732) Californian Beverages Limited

(111) 164 /2017; (156) 06.02.2024.
(511) Int. Cl. 32.

(540) **CALIFORNIAN FROOTY**

(732) Californian Beverages Limited

(111) 166 /2017; (156) 06.02.2024.
(511) Int. Cl. 16.

(540) **NDALAMA**

(732) Kakoshi Investments Limited

(111) 156 /2017; (156) 06.02.2024.
(511) Int. Cl. 32.

(540) **HUBBLY BUBBLY**

(732) Californian Beverages Limited

(111) 163 /2017; (156) 06.02.2024.
(511) Int. Cl. 32.

(540) **HUMMING BIRD APPLE**

(732) Californian Beverages Limited

(111) 145 /2017; (156) 06.02.2024.
(511) Int. Cl. 32.

(540) **SWIFT NAARTJIE MANDARIN**

(732) Californian Beverages Limited

(111) 146 /2017; (156) 06.02.2024.
(511) Int. Cl. 32.

(540) **TING LING GINGER BEER**

(732) Californian Beverages Limited

(111) 144 /2017; (156) 06.02.2024.
(511) Int. Cl. 32.

(540) **SWIFT MIXED BERRY**

(732) Californian Beverages Limited

(111) 150 /2017; (156) 06.02.2024.
(511) Int. Cl. 32.

(540) **JUST PINEAPPLE**

(732) Californian Beverages Limited

(111) 152 /2017; (156) 06.02.2024.

(511) Int. Cl. 32.

(540) **JUST GRANADILLA**

(732) Californian Beverages Limited

(111) 143 /2017; (156) 06.02.2024.

(511) Int. Cl. 32.

(540) **CALIFORNIAN CACTOVERRA**

(732) Californian Beverages Limited

(111) 147 /2017; (156) 06.02.2024.

(511) Int. Cl. 32.

(540) **MOTT'S RASPBERRY**

(732) Californian Beverages Limited

(111) 149 /2017; (156) 06.02.2024.

(511) Int. Cl. 32.

(540) **MOTT'S ORANGE**

(732) Californian Beverages Limited

(111) 151 /2017; (156) 06.02.2024

(511) Int. Cl. 32.

(540) **JUST ORANGE**

(732) Californian Beverages Limited

(111) 153 /2017; (156) 06.02.2024.

(511) Int. Cl. 32.

(540) **AQUAMAX**

(732) Californian Beverages Limited

(111) 154 /2017; (156) 06.02.2024.

(511) Int. Cl. 32.

(540) **MINTMAX**

(732) Californian Beverages Limited

(111) 155 /2017; (156) 06.02.2024.

(511) Int. Cl. 32.

(540) **GRAPEMAX**

(732) Californian Beverages Limited

(111) 157 /2017; (156) 06.02.2024.

(511) Int. Cl. 32.

(540) **FROOTY**

(732) Californian Beverages Limited

(111) 159 /2017; (156) 06.02.2024.

(511) Int. Cl. 32.

(540) **CALI-COLA**

(732) Californian Beverages Limited

(111) 154 /2017; (156) 06.02.2024.

(511) Int. Cl. 32.

(540) **MINTMAX**

(732) Californian Beverages Limited

(111) 161 /2017; (156) 06.02.2024.

(511) Int. Cl. 32.

(540) **HUMMING BIRD GUAVA**

(732) Californian Beverages Limited

(111) 165 /2017; (156) 06.02.2024.

(511) Int. Cl. 32.

(540) **CALIFORNIAN CACTOVERA**

(732) Californian Beverages Limited.

(111) 167 /2017; (156) 07.02.2024.

(511) Int. Cl. 32.

(540) **THE REAL MEAT AFRICA COMPANY LIMITED CORPORATE**

(732) The Real Meat Africa Company Limited

(111) 172/2017; (156) 08.02.2024.

(511) Int. Cl. 16.

(540) **Southern Sun**
(732) Southern Sun Hotel Interests (Proprietary) Limited

(111) 174/2017; (156) 08.02.2024. X
(511) Int. Cl. 8.

(540) **Southern Sun**
(732) Southern Sun Hotel Interests (Proprietary) Limited

(111) 176/2017; (156) 08.02.2024.
(511) Int. Cl. 29.

(540) **Southern Sun**
(732) Southern Sun Hotel Interests (Proprietary) Limited

(111) 177/2017; (156) 08.02.2024.
(511) Int. Cl. 30.
(540) **Southern Sun**
(732) Southern Sun Hotel Interests (Proprietary) Limited

(111) 184/2017; (156) 09.02.2024.
(511) Int. Cl. 9.
(540) **MyChilimba**
(732) Zambia National Commercial Bank Plc

(111) 185/2017; (156) 09.02.2024.
(511) Int. Cl. 16.
(540) **MyChilimba**
(732) Zambia National Commercial Bank Plc

(111) 183/2017; (156) 09.02.2024.
(511) Int. Cl. 34.
(540) **CYCLE SAFETY MATCHES**
(732) Shriman Zambia Limited.

(111) 187/2017; (156) 09.02.2024.
(511) Int. Cl. 9.

(540) **DIRECT PAY ONLINE THE HOME OF ONLINE PAYMENT Logo**

(732) 3G Direct Pay Limited

(111) 194/2017; (156) 09.02.2024.

(511) Int. Cl. 16.

(540) **MANJA PAMODZI**

(732) Zambian Breweries Plc

(111) 199/2017; (156) 13.02.2024.

(511) Int. Cl. 9.

(540) **COW Logo**

(732) Emcure Pharmaceuticals Limited

(111) 216/2017; (156) 13.02.2024.

(511) Int. Cl. 4.

(540) **NISSAN & Device**

(732) Nissan Jidosha Kabushiki Kaisha

(111) 217/2017; (156) 13.02.2024.

(511) Int. Cl. 7.

(540) **NISSAN & Device**

(732) Nissan Jidosha Kabushiki Kaisha

(111) 195/2017; (156) 13.02.2024.

(511) Int. Cl. 30.

(540) **SOYJOY**

(732) Shree Keshariya Enterprises

(111) 201/2017; (156) 13.02.2024.

(511) Int. Cl. 1.

(540) **DATSUN (new logo)**

(732) Nissan Jidosha Kabushiki Kaisha (also trading as Nissan Motor Co.,Ltd)

(111) 202/2017; (156) 13.02.2024.

(511) Int. Cl. 2.

(540) **DATSUN (new logo)**

(732) Nissan Jidosha Kabushiki Kaisha(also trading as Nissan Motor Co.,Ltd)

(111) 203/2017; (156) 13.02.2024.

(511) Int. Cl. 3.

(540) **DATSUN (new logo)**

(732) Nissan Jidosha Kabushiki Kaisha(also trading as Nissan Motor Co.,Ltd)

(111) 204/2017; (156) 13.02.2024.

(511) Int. Cl. 5.

(540) **DATSUN (new logo)**

(732) Nissan Jidosha Kabushiki Kaisha(also trading as Nissan Motor Co.,Ltd)

(111) 205/2017; (156) 13.02.2024.

(511) Int. Cl. 6.

(540) **DATSUN (new logo)**

(732) Nissan Jidosha Kabushiki Kaisha(also trading as Nissan Motor Co.,Ltd)

(111) 206/2017; (156) 13.02.2024.

(511) Int. Cl. 8.

(540) **DATSUN (new logo)**

(732) Nissan Jidosha Kabushiki Kaisha(also trading as Nissan Motor Co.,Ltd)

(111) 207/2017; (156) 13.02.2024.

(511) Int. Cl. 11.

(540) **DATSUN (new logo)**

(732) Nissan Jidosha Kabushiki Kaisha(also trading as Nissan Motor Co.,Ltd)

(111) 208/2017; (156) 13.02.2024.

(511) Int. Cl. 14.

(540) **DATSUN (new logo)**

(732) Nissan Jidosha Kabushiki Kaisha(also trading as Nissan Motor Co.,Ltd)

(111) 209/2017; (156) 13.02.2024.

(511) Int. Cl. 16.

(540) **DATSUN (new logo)**

(732) Nissan Jidosha Kabushiki Kaisha(also trading as Nissan Motor Co.,Ltd)

(111) 210/2017; (156) 13.02.2024.

(511) Int. Cl. 18.

(540) **DATSUN (new logo)**

(732) Nissan Jidosha Kabushiki Kaisha(also trading as Nissan Motor Co.,Ltd

(111) 211/2017; (156) 13.02.2024.

(511) Int. Cl. 21.

(540) **DATSUN (new logo)**

(732) Nissan Jidosha Kabushiki Kaisha(also trading as Nissan Motor Co.,Ltd

(111) 212/2017; (156) 13.02.2024.

(511) Int. Cl. 24.

(540) **DATSUN (new logo)**

(732) Nissan Jidosha Kabushiki Kaisha(also trading as Nissan Motor Co.,Ltd

(111) 213/2017; (156) 13.02.2024.

(511) Int. Cl. 25.

(540) **DATSUN (new logo)**

(732) Nissan Jidosha Kabushiki Kaisha(also trading as Nissan Motor Co.,Ltd

(111) 214/2017; (156) 13.02.2024.

(511) Int. Cl. 27.

(540) **DATSUN (new logo)**

(732) Nissan Jidosha Kabushiki Kaisha(also trading as Nissan Motor Co.,Ltd

(111) 215/2017; (156) 13.02.2024.

(511) Int. Cl. 28.

(540) **DATSUN (new logo)**

(732) Nissan Jidosha Kabushiki Kaisha(also trading as Nissan Motor Co.,Ltd

(111) 196/2017; (156) 13.02.2024.

(511) Int. Cl. 12.

(540) **ZETOR**

(732) HTC Holding, a.s.

(111) 230/2017; (156) 17.02.2024.

(511) Int. Cl. 7.

(540) **WHIRPOOL LOGO**

(732) Whirlpool Properties, Inc.

(111) 234/2017; (156) 17.02.2024.

(511) Int. Cl. 32.

(540) **AQUAMAX**

(732) Californian Beverages Limited.

(111) 235/2017; (156) 17.02.2024.

(511) Int. Cl. 32.

(540) **AQUAMAX**

(732) Californian Beverages Limited.

(111) 279/2017; (156) 20.02.2024.

(511) Int. Cl. 09.

(540) **REMCHANNEL**

(732) PWC Research Services (Pty) Ltd

(111) 262/2017; (156) 21.02.2024.

(511) Int. Cl. 12.

(540) **NDOVU**

(732) Shinyanga Emporium 1978 limited

(111) 266/2017; (156) 21.02.2024.

(511) Int. Cl. 12.

(540) **BISON BICYCLES**

(732) Shinyanga Emporium 1978 limited.

(111) 263/2017; (156) 21.02.2024.

(511) Int. Cl. 8.

(540) **NDOVU**

(732) Shinyanga Emporium 1978 limited

(111) 264/2017; (156) 21.02.2024.

(511) Int. Cl. 7.

(540) **NDOVU**

(732) Shinyanga Emporium 1978 limited

(111) 241/2017; (156) 21.02.2024.

(511) Int. Cl. 3.

(540) **LION**

(732) Lion Corporation

(111) 242/2017; (156) 21.02.2024.

(511) Int. Cl. 21.

(540) **LION**

(732) Lion Corporation

(111) 261/2017; (156) 21.02.2024.

(511) Int. Cl. 09.

(540) **LIFE TELEVISION**

(732) Covenant Hills Limited

(111) 268/2017; (156) 21.02.2024.

(511) Int. Cl. 03.

(540) **MO HALISI LABEL**

(732) MetL Zambia Limited

(111) 251/2017; (156) 21.02.2024.

(511) Int. Cl. 03.

(540) **KIWI BIRD DESIGN**

(732) S.C Johnson & Son, Inc

(111) 277/2017; (156) 22.02.2024.

(511) Int. Cl. 30.

(540) **LALA LOOPS SPRING ONION**

(732) Yoyo Foods Limited

(111) 280/2017; (156) 22.02.2024.

(511) Int. Cl. 16.

(540) **REMCHANNEL**

(732) PWC Research Services (Pty) Ltd

(111) 281/2017; (156) 22.02.2024.

(511) Int. Cl. 9.

(540) **REMEASURE**

(732) PWC Research Services (Pty) Ltd

(111) 282/2017; (156) 22.02.2024.

(511) Int. Cl. 16.

(540) **REMEASURE**

(732) PWC Research Services (Pty) Ltd

(111) 284/2017; (156) 22.02.2024.

(511) Int. Cl. 16.

(540) **REMPROFILE**

(732) PWC Research Services (Pty) Ltd

(111) 288/2017; (156) 23.02.2024.

(511) Int. Cl. 9.

(540) **GRACE OF GOD CHAIRS**

(732) Arkay Plastics Zambia Ltd

(111) 293/2017; (156) 24.02.2024.

(511) Int. Cl. 1.

(540) **IMIGO**

(732) UPL Corporation Limited

(111) 294/2017; (156) 24.02.2024.

(511) Int. Cl. 5.

(540) **IMIGO**

(732) UPL Corporation Limited

(111) 312/2017; (156) 28.02.2024.

(511) Int. Cl. 5.

(540) **HAMSYL**

(732) Gennova Biopharmaceuticals Ltd

(111) 310/2017; (156) 28.02.2024.

(511) Int. Cl. 1.

(540) **FALCON LOGO**

(732) ETG Inputs Holdco Ltd

(111) 313/2017; (156) 28.02.2024.

(511) Int. Cl. 5.

(540) **ELAXIM**

(732) Gennova Biopharmaceuticals Ltd

(111) 323/2017; (156) 28.02.2024.

(511) Int. Cl. 1.

(540) **COOL GEAR LOGO**

(732) Denso Corporation

(111) 326/2017; (156) 28.02.2024.

(511) Int. Cl. 11.

(540) **COOL GEAR LOGO**

(732) Denso Corporation

(111) 324/2017; (156) 28.02.2024.

(511) Int. Cl. 4.

(540) **COOL GEAR LOGO**

(732) Denso Corporation

(111) 325/2017; (156) 28.02.2024.

(511) Int. Cl. 7.

(540) **COOL GEAR LOGO**

(732) Denso Corporation

STATUTORY NOTICES UNDER THE TRADE MARKS ACT (CAP. 401)

TRADE MARK REGISTRATIONS REQUEST FOR RESTORATION OF LAPSED TRADEMARKS FOR MARCH, 2024. (NE)

THE FOLLOWING trade mark registrations listed below have been renewed and restored in accordance with Section 25 of the Trade Marks Act for 14years with effect from the date indicated in Code (156).

(111) 889/2006; (156) 14.03.2024.

(731) (750) Conservation Farmer Wildlife Producer Trading Centre, Plot 92, Hospital Road, P.O.

Box 530225, Lundazi, Zambia.

(511) Int. Cl. 25.

(510) Caps and t-shirts.

(541) **COMACO & Logo**

(111) 890/2006; (156) 14.03.2024.

(731) (750) Conservation Farmer Wildlife Producer Trading Centre, Plot 92, Hospital Road, P.O.

Box 530225, Lundazi, Zambia.

(511) Int. Cl. 29.

(510) Peanut butter.

(541) **IT'S WILD & DEVICE**

STATUTORY NOTICES UNDER THE TRADE MARKS ACT (CAP. 401)

TRADE MARK REGISTRATIONS FOR CANCELLATION OFF THE REGISTER.

THE FOLLOWING trade mark registrations listed below have been emarked as cancelled off the Register.

(210) 132/2020; (220) 27.01.2020.

(731) MFS Africa of Felix House, 24 Dr Joseph Riviere Street, Port-Louis, Mauritius.

(740) Christopher, Russell Cook & Co., 4658/A Chikwa Road, P.O Box 34091, Lusaka, Zambia.

(511) Int. Cl. 9.

(510) Computer software, mobile apps and electronic payment apparatus.

MFS AFRICA

(540)

STATUTORY NOTICES UNDER THE INDUSTRIAL DESIGNS ACT (NO. 22)

INDUSTRIAL DESIGNS FILED DURING FEBRUARY, 2024. (AA)

THE FOLLOWING Designs were filed on the date indicated in Code (22).

(21) D.10/2024; (22) 6.2.2024

(51) Int. Cl.9 09-01

(54) **A 500 ML PLASTIC BOTTLE**

(71) Acacia Food & Beverage Limited, Plot No. 8492, Njanshinshi Road, off Mumbwa Road, Chinika, P.O. Box 35879, Lusaka.

(21) D.11/2024; (22) 6.2.2024

(51) Int. Cl.9 09-01

(54) **A 500ML PLASTIC BOTTLE (NEW DESIGN) YESS**

(71) Acacia Food & Beverage Limited, Plot No. 8492, Njanshinshi Road, off Mumbwa Road, Chinika, P.O. Box 35879, Lusaka.

(21) D.12/2024; (22) 20.2.2024

(51) Int. Cl.9 09-01

(54) **375 MLS GLASS BOTTLE**

(71) Decent Spirit Zambia Limited, Plot 3294 Industrial Area, P.O. Box 71427, Ndola.

(21) D.13/2024; (22) 20.2.2024

(51) Int. Cl.9 09-01

(54) **500 ML PLASTIC BOTTLE (WATER DROP)**

(71) Acacia Food & Beverage Limited, Plot No. 8492, Njanshinshi Road, off Mumbwa Road, Chinika, P.O. Box 35879, Lusaka.

ERRATA

The Application below was advertised in the 25th January, 2024 Industrial Property Journal with the wrong logo instead of wordmark. The correct full details are as highlighted in the Code (540)

(210) 2036/2023; (220) 24.11.2023.

(731) L.K. Luca Franchise Management Limited.

(740) Christopher, Russell Cook & Co., 4658/A Chikwa Road, P.O Box 34091, Lusaka, Zambia

(511) Int Cl. 29.

(510) Meat, fish, poultry and game; meat extracts; preserved, frozen, dried and cooked fruits and vegetables; jellies, jams, compotes; eggs; milk, cheese, butter, yogurt and other milk products; oils and fats for food.

(541) MOCHACHOS

The Application below was advertised in the 25th February, 2024 Industrial Property Journal with typographical errors in the proprietors name and specification of goods. The correct full details are as highlighted in Codes (731) and (510)

(210) 2201/2023; (220) 29.11.2023.

(731) Shenzhen Ecovol New Energy Technology Co., Ltd

(740) Eric Silwamba, Jalasi & Linyama Legal Practitioners, No.12 Chilekwa Mwamba Road, Off Lubu/Saise Roads, Longacres, Lusaka, Zambia

(511) Int Cl.9.

(510) Inverters [electricity], photovoltaic inverters, photovoltaic cells; batteries, electric; battery chargers, rechargeable batteries, galvanic cells, computer software applications, downloadable; battery testers, battery charge device.

(540)



The Application below was advertised in the 25th February, 2024 Industrial Property Journal with some godos missing from list. The correct full details are as highlighted in Code (510)

(210) 1838/2023;

(220) 23.10.2023

(731) Fengfan Co. Limited

(740) Eric Silwamba, Jalasi & Linyama Legal Practitioners, No.12 Chilekwa Mwamba Road, Off Lubu/Saise Roads, Longacres, Lusaka, Zambia

(510) accumulators, electric; accumulator jars; batteries, electric; grids for batteries; accumulators, electric, for vehicles; high tension batteries; accumulator boxes; chargers for electric batteries; Rechargeable batteries; galvanic cells.

(511) Int Cl.9



(540)

The Application below was advertised in the 25th October, 2023 Industrial Property Journal as with wrong proprietor Name. The correct full details are as highlighted in Code (731).

(210) 1173/2023;

(156) 24.07.2023

(511) Int Cl.7

(731) Axis Mining and Logistics Limited Plot No. 8088, Nakambala Road, Ndola, Copperbelt Province, Zambia.

(740) Kenite Corporate Consultancy and Advisory, Plot No. 4, Libala, Lusaka.

(510) pumps [machines], pumps [parts of machines, engines or motors, vacuum pumps [machines], welding machines, electric, tools [parts of machines] compressed air pumps



(540)

The Application below was advertised in the 31st October, 2022 Industrial Property Journal with the wrong Trademark Number, typographical errors in the class of goods and its description. The correct full details are as highlighted in Codes (210), (510) and (511).

(210) 871/2022;

(220) 07.07.2022.

(731) SmithKline Beecham Limited of 980 Great West Road Brentford, Middlesex TW8 9GS, Middlesex, Great Britian.

(740) Fisher, Cormack & Botha, P.O Box 33890, Lusaka, Zambia.

(510) Pharmaceutical and medicinal preparations and substances; chemical, biochemical and biological preparations and agents for medical purposes; therapeutic agents (medical); adhesive patches for medical purposes; adhesive patches for surgical purposes; adhesive patches incorporating a pharmaceutical preparation; medicated patches, plasters and dressings for the treatment of skin diseases, conditions and disorders; vaccines; adjuvants for medical purposes; vitamins, minerals and food supplements; dietary preparations; dietary supplements and dietetic preparations; diagnostic preparations; disinfectants and antiseptics; medical dressings, coverings and applicators; pharmaceuticals and natural remedies; medicated and sanitising soaps and detergents; sanitary preparations and articles; drug delivery agents that facilitate the delivery of pharmaceutical preparations.

(511) Int Cl.5.



(540)

The Application below was advertised in the 25th January, 2024 Industrial Property Journal wrongly as lapsed. Kindly note that, the trade mark registrations have been renewed in accordance with Section 25 of the Trade Marks Act for 14 years with effect from the date indicated in Code (220) highlighted.

(210) 672/2022;

(220) 19.09.2023

(731) Glaxo Group Limited of GSK Medicines Research Centre, Gunnels Wood Road, Stevenage SG1 2NY, United Kingdom.

(510) Electric publication, database and electronic catalogues and software for use therewith; media containing recorded sounds, images or data CD-ROM's down loadable publications in electronic format; magnetic data carries, recording discs, tapes, CD's cassettes, DVD's, computer software supplied from the internet; down loadable electronic publications provided on line from database or the internet included in class 9.

(511) Int Cl.9.

(541) **VENTOLINE**

The Application below was advertised in the **25th November, 2023** Industrial Property Journal with typographical error on the proprietor's address and classification of goods description. Further the Journal Indicated a wrong description of the Word mark as '**FIGURATIVE**' instead of '**ILIMA RINGS Logo**' The correct full details of the address are as highlighted in Codes (731) (510) and (540).

(210) 1930/2023; (220) 26.10.2023.

(731) Phillip Morris Products **S.A.**, of Quai Jeanrenaud 3, **Neuchatel** 2000, Switzerland.

(740) Christopher, Russell Cook & Co., 4658/A Chikwa Road, P.O Box 34091, Lusaka, Zambia.

(511) Int Cl.34.

(510) Wired vaporizer for electronic cigarettes and electronic smoking devices; tobacco, raw or manufactured; tobacco products, including cigars, cigarettes, cigarillos, tobacco for roll your own cigarettes, pipe tobacco, chewing tobacco, snuff tobacco, kretek; snus; tobacco substitutes (not for medical purposes); **smokers articles**, including cigarette paper and tubes, cigarette filters, tobacco tins, cigarette cases and ashtrays for **smokers**, pipes, pocket apparatus for rolling cigarettes, lighters for smokers; matches; tobacco sticks, tobacco products for the purpose of being heated, electronic devices and their parts for the purpose of heating cigarettes or tobacco in order to release nicotine-containing aerosol for inhalation; liquid nicotine solutions for use in electronic cigarettes; electronic smoking devices; electronic cigarettes; electronic cigarettes as substitute for traditional cigarettes; electronic devices for the inhalation of nicotine containing aerosol; oral vaporising devices for smokers, tobacco products and tobacco substitutes; smoker's articles for electronic cigarettes; parts and fittings for the aforesaid products included in class 34; devices for extinguishing heated cigarettes and cigars as well as heated tobacco sticks; electronic rechargeable cigarette cases.

(540)



The Application below was advertised in the 25th February, 2024 Industrial Property Journal with disclaimer missing. The correct full details are as highlighted in Code (526)

(210) 1372/2017; (220) 23.08.2017.

(731) Pearl Dairy Farms Ltd of Migamba Village, Nyakinengo Ward, Biharwe Division, Mbarara, Uganda.

(740) Christopher, Russell Cook & Co., 4658/A Chikwa Road, P.O Box 34091, Lusaka, Zambia.

(511) Int Cl.29

(510) Milk and milk products; edible oils and fats.

(526) Registration of this trade mark shall give no exclusive right to the use of the Word 'Milk' separately and apart from the mark as a whole. Applicants admit that registration of this trade mark shall not debar persons from the bona fide descriptive use, in ordinary course of trade of the cow device.



(540)

The Application below was advertised in the 25th February, 2024 Industrial Property Journal with disclaimer missing. The correct full details are as highlighted in Code (526)

(210) 1373/2017; (220) 23.08.2017.

(731) Pearl Dairy Farms Ltd of Migamba Village, Nyakinengo Ward, Biharwe Division, Mbarara, Uganda.

(740) Christopher, Russell Cook & Co., 4658/A Chikwa Road, P.O Box 34091, Lusaka, Zambia.

(511) Int Cl.29

(510) Milk and milk products; edible oils and fats.

(526) Registration of this trade mark shall give no exclusive right to the use of the Word
'Butter' separately and apart from the mark as a whole.



(540)

The Application below was advertised in the 25th November, 2023 Industrial Property Journal with typographical errors on the class of goods. The correct full details are as highlighted in Code (511)

(210) 1022/2023; (220) 11.07.2023.

(731) ABSA Bank Limited of 15 Troye Street, Johannesburg, South Africa

(740) Christopher, Russell Cook & Co., 4658/A Chikwa Road, P.O Box 34091, Lusaka, Zambia.

(511) Int Cl.16.

(510) Paper and cardboard; printed matter; bookbinding material; photographs; stationery and office requisites, except furniture; adhesives for stationery or household purposes; drawing materials and materials for artists; paintbrushes; instructional and teaching materials; plastic sheets, films and bags for wrapping and packaging; printers' type, printing blocks; printed matter representing monetary value or for financial purposes; financial documents; financial planning guides; printed publications relating to financial services; newsletters.

ABSA CHATWALLET

(540)

The Application below was advertised in the 25th January, 2024 Industrial Property Journal wrongly as not renewed. Kindly note that, the trade mark registrations have been renewed in accordance with Section 25 of the Trade Marks Act for 14 years with effect from the date indicated in Code (220) highlighted.

(210) 1133/1960; (220) 18.08.2023

(731) Tioxide Europe Limited, Lincoln House, 137-143 Hammersmith Road, London, England.

(740) Fisher, Cormack & Botha P. O. Box 33890, Lusaka, Zambia.

(510) Pigments being or containing oxides

(511) Int Cl.2.

(541) **TIOXIDE**

The Application below was advertised in the 25th January, 2024 Industrial Property Journal wrongly as not renewed. Kindly note that, the trade mark registrations have been renewed in accordance with Section 25 of the Trade Marks Act for 14 years with effect from the date indicated in Code (220) highlighted.

(210) 473/2002; (220) 26.02.2024

(731) Hisamitsu Pharmaceutical Co Inc, 408, Tashiro Daikancho, Tosu, Saga, Japan.

(740) Fisher, Cormack & Botha P. O. Box 33890, Lusaka, Zambia.

(510) Pharmaceutical and veterinary preparations, sanitary preparations for medical purposes, dietetic substances adapted for medical use, food for babies, plasters materials for dressings, material for stopping teeth, dental wax, disinfectants, preparations for destroying vermin, fungicides, herbicides.

(511) Int Cl.5.

(540) 

The Application below was advertised in the 25th February, 2024 Industrial Property Journal with the wordmark instead of logo and disclaimer missing. The correct full details are as highlighted in the Code (540)

(210) 1827/2023;

(220) 23.10.2023.

(731) Clicks Retailers Proprietary Limited of Cnr Searle & Pontac Streets, Cape Town, Western Cape, South Africa.

(740) Christopher, Russell Cook & Co., 4658/A Chikwa Road, P.O Box 34091, Lusaka, Zambia.

(511) Int Cl. 3.

(526) Registration of this trademark shall give no exclusive right to the letters “**N,U,D** and **E**” separately except in the stylised manner and as represented on the form of application.

(510) Non-medicated cosmetics and toiletry preparations; non-medicated lotions; non-medicated dentifrices; perfumery, essential oils; bleaching preparations and other substances for laundry use; cleaning, polishing, scouring and abrasive preparations.

(540) 

KEY TO CODES USED IN KEY TO CODES USED IN THIS JOURNAL (WIPO ST.3) THIS JOURNAL (WIPO ST.3)

INID CODES FOR DETAILS OF ANNOUNCEMENTS

INID Code	<i>Representation in Patent Announcements (ST.9)</i>	<i>Representation in Designs Announcements (ST.80)</i>	INID Code	<i>Representation in Trade Marks Announcements (ST.60)</i>
(11)	Number of the patent	Registration number	(111)	Registration number
(15)	-	Date of the registration/renewal	(141)	Effective date of termination of registration
(17)	-	Expected duration of the registration/renewal	(151)	Effective date of registration of trade mark
(18)	-	Identification of the authority publishing or registering the industrial design (ST.3)	(156)	Effective date of renewal of registration
(19)	identification, of the office or organization publishing the document (ST.3)		(190)	Identification using the two-letter code of the authority registering the mark
(21)	Number(s) assigned to the application(s)	Application number	(210)	Serial number of the application
(22)	Date(s) of filing the application	Date of filing of the application	(220)	Application number Date of filing
(23)	Other date(s), including date of filing complete specification following provisional specification and date of exhibition	Name and place of exhibition, and date on which the industrial design was first exhibited there	(310)	Priority number
(24)	Date from which industrial property rights may have effect	Date from which the industrial design has effect	(320)	Priority date
(25)	Language in which published application was originally filed		(330)	Convention country
(26)	Language in which application is published	Indication of the form in which the industrial design is filed	(510)	List of goods covered
(29)	-	Priority number	(511)	Class number of the international Nice Classification
(31)	Priority date	Priority date	(521)	Indication to the effect that the mark has acquired distinctiveness through use in trade
(32)	Convention country	Convention country	(525)	Indication that the mark has been cancelled for non-use
(33)	International Patent Classification	Class mark of the International Locarno Classification	(526)	Disclaimer
(51)	Title of the invention	Title of the design	(527)(529)	Indications regarding use requirements
(54)	Abstract or claim	Abstract of design	(540)	Indications regarding use limitations
(57)	Number and filing date of earlier independent application or grant	Number and filing date of registered current application depends under for extension of that design to other goods under section 10	(541)	Reproduction of trade mark
(51)	on which current application depends under section 31 as application for the patent of addition	Name(s) and address(es) of the applicant(s)	(551)	Reproduction of the mark where the mark is represented in standard characters
(71)	Name(s) and address(es) of applicants	Name(s) of the creator(s) if known to be such	(558)	Reproduction of the mark where the mark is represented in non-standard characters
(72)	Name(s) of inventor(s) is known to be such	Name(s) and address(es) of the owner(s)	(591)	Indication to the effect that the mark is a collective mark, a certification mark or a guarantee mark
(73)	Name(s) of grantee(s), holder(s), assignee(s) or owner(s)	Name(s) and address(es) of the representative(s)	(641)	Mark consisting exclusively of one or several colours
(74)	Name(s) and address(es) of local attorney(s) or agents	Name(s) and address(es) of the new owner(s) in case of change in ownership	(646)	Information concerning colours claimed
(75)	Name(s) of inventor(s) who is (are) also applicants		(561)	Number(s) of other related application(s)
			(566)	Number(s) of other related trade mark registration(s)
			(730)(731)	Transliteration of the mark
			(732)	Translation of the mark or of words contained in the mark
			(730)	Name and address of the applicant or the holder of the registration
			(740)	Name(s) and address(es) of the applicant(s)
			(750)	
			(791)	
			(793)	

	Name(s) of inventor(s) who is (are) also applicants & grantee(s) -			Name and address of the holder of the registration Name(s) and address(es) of local attorney(s) Correspondence address of the applicant or proprietor where attorney in code (740) is unavailable Licensee's name and address Conditions and/or restrictions under the licence
--	---	--	--	--

LETTER CODES (STATUS CODES) FOR HEADINGS OF ANNOUNCEMENTS (WIPO ST.17)

<i>Code</i>	<i>Representation</i>	<i>Code</i>	<i>Representation</i>	<i>Code</i>	<i>Representation</i>
(AA)	New Application not yet published	(HK)	Erratum for an industrial property that is in a stage up to date of	(NE)	Request for restoration of registration of an IP
(BB)	for public inspection	(KC)	grant/registration	(PC)	Registered IP assigned.
(CA)	Application accepted and published	(MC)	Fee for renewal or extension of	(PE)	IP now open to free public use.
(DC)	by laying open for public inspection	(MM)	registration of an IP not paid for	(QB)	Registration of licence for use of
(FG)	Opposition invited from the public	(NO)	Full term of registration expired (for patents and designs only)	(TH)	a Registered IP
	Amendment of the specification or claims accepted		Termination of registration of an IP		Correction or change in general
	New grant / registration of an Industrial Property (IP)		due to non-renewal.		
			Registration term of an IP renewed or extended		